

Indus-c[®]



- M12 according to IEC 61076-2-101 has 3pins, 4pins, 5pins, 8pins, 12pins, 17pins with a rated current up to 4 A at 250 V. The highest waterproof grade is IP69K. Any length is available. There are easy to assemble flange versions with various connection options such as solder and dip solder termination and stranded wires. They have excellent EMC shielding and are available for outdoor and food and beverage applications. Indus-connector always provide customized design to cover the whole requirement.

- 依据国际IEC 61076-2-101标准, M12有3针/孔、4针/孔、5针/孔、8针/孔、12针/孔、17针/孔, 电流最高达到4A, 电压最高达到250V。最高防水等级为IP69K。

M12 male plastic waterproof cap/M12公头塑胶防水帽

Scale drawing/尺寸图

Product photo/产品图

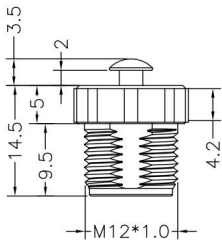

Part number/产品料号

12CAP003

General data/常规数据

Standards/标准	IEC 61076-2-101
Degree of protection/防护等级	IP67, IP68, IP69K
Screw/螺丝	Nylon/尼龙
Customs tariff number/海关编码	8538900000
Environmental compliance/环境符合标准	RoHs, Reach

M12 female plastic waterproof cap/M12母头塑胶防水帽

Scale drawing/尺寸图

Product photo/产品图

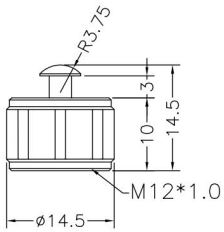

Part number/产品料号

12CAP004

General data/常规数据

Standards/标准	IEC 61076-2-101
Degree of protection/防护等级	IP67, IP68, IP69K
Gasket/胶圈	Fluorine ring/氟胶圈
Screw/螺丝	Nylon/尼龙
Customs tariff number/海关编码	8538900000
Environmental compliance/环境符合标准	RoHs, Reach

M12 male plastic waterproof cap with plastic chain/M12公头塑胶防水帽带塑胶绳

Scale drawing/尺寸图

Product photo/产品图

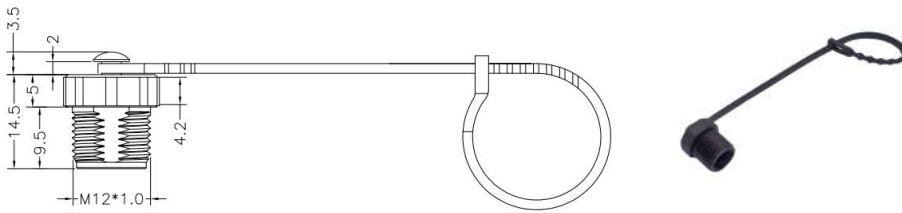

Part number/产品料号

12CAP020

General data/常规数据

Standards/标准	IEC 61076-2-101
Degree of protection/防护等级	IP67, IP68, IP69K
Screw/螺丝	Nylon/尼龙
Chain/绳子	Nylon/尼龙
Customs tariff number/海关编码	8538900000
Environmental compliance/环境符合标准	RoHs, Reach

M12 female plastic waterproof cap with plastic chain/M12母头塑胶防水帽带塑胶绳

Scale drawing/尺寸图

Product photo/产品图

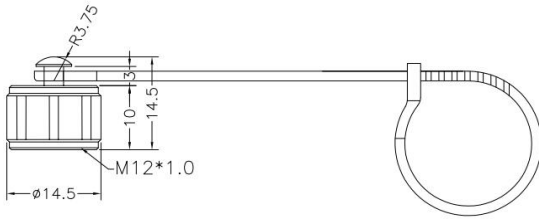

Part number/产品料号

12CAP021

General data/常规数据

Standards/标准	IEC 61076-2-101
Degree of protection/防护等级	IP67, IP68, IP69K
Gasket/胶圈	Fluorine ring/氟胶圈
Screw/螺丝	Nylon/尼龙
Chain/绳子	Nylon/尼龙
Customs tariff number/海关编码	8538900000
Environmental compliance/环境符合标准	RoHs, Reach

M12 male metal waterproof cap with stainless steel chain/M12公头防水帽带不锈钢绳

Scale drawing/尺寸图

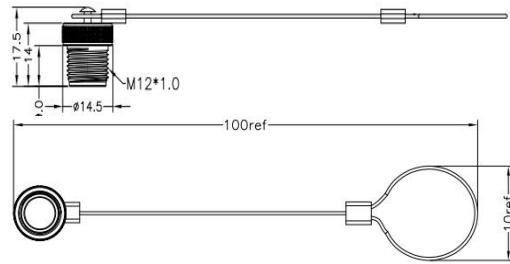

Product photo/产品图



Part number/产品料号

12CAP005-100

General data/常规数据

Standards/标准	IEC 61076-2-101
Degree of protection/防护等级	IP67, IP68, IP69K
Screw/螺丝材料	Brass with nickel plated/黄铜镀镍
Chain/绳子	Stainless steel/不锈钢
Customs tariff number/海关编码	8538900000
Environmental compliance/环境符合标准	RoHs, Reach

M12 female metal waterproof cap with stainless steel chain/M12母头防水帽带不锈钢绳

Scale drawing/尺寸图

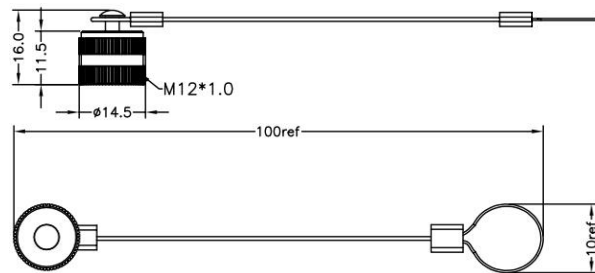

Product photo/产品图



Part number/产品料号

12CAP006-100

General data/常规数据

Standards/标准	IEC 61076-2-101
Degree of protection/防护等级	IP67, IP68, IP69K
Gasket/胶圈	Fluorine ring/氟胶圈
Screw/螺丝	Brass with nickel plated/黄铜镀镍
Chain/绳子	Stainless steel/不锈钢
Customs tariff number/海关编码	8538900000
Environmental compliance/环境符合标准	RoHs, Reach

M12 A code male moldable connector, unshielded/M12,A型公头成型式连接器, 不带屏蔽

Scale drawing/尺寸图

Product photo/产品图

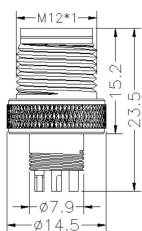

Part number/产品料号

Pins/针数	Code/型	Part number/产品料号
3pins/3针	A code/A型	12C098
4pins/4针	A code/A型	12C059
5pins/5针	A code/A型	12C067
8pins/8针	A code/A型	12C100
12pins/12针	A code/A型	12C090
17pins/17针	A code/A型	12C119

Pin assignment front view/针位分布前视图

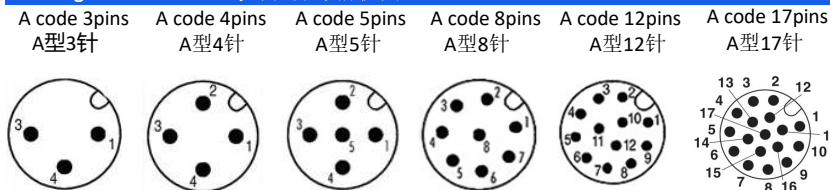

General data/常规数据

Pin Numbers/针数	3pins/3针	4pins/4针	5pins/5针	8pins/8针	12pins/12针	17pins/17针
Rated voltage/额定电压	250V		60V	30V		
Rated current(40°C)/额定电流	4A			2A	1.5A	1.5A
Standards/标准	IEC 61076-2-101					
Termination/焊接方式	Solder/焊接					
Connector locking system	Screw/螺锁					
Degree of protection/防护等级	IP67, IP68, IP69K					
Wire gauge(mm²)/线规(平方数)	0.14mm²-0.75mm²					
Wire gauge(AWG)/线号(平方数)	26AWG-18AWG					
Mechanical operation/插拔次数	>100 mating cycles/大于100次					
Ambient temperature (operation)/操作温度	-25°C~+85°C					
Contact resistance/接触电阻	≤5mΩ					
Insulation resistance/绝缘电阻	≥100MΩ					
Connector body/胶芯	TPU					
Pin/端子	Brass with gold plated/黄铜镀金					
Screw/螺丝	Brass with nickel plated/黄铜镀镍					
Customs tariff number/海关编码	8538900000					
Environmental compliance/环境符合标准	RoHs, Reach					

M12 A code female moldable connector, unshielded/M12,A型母头成型式连接器, 不带屏蔽

Scale drawing/尺寸图

Product photo/产品图

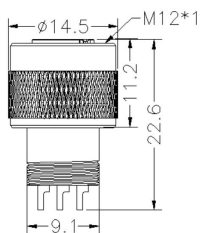

Part number/产品料号

Pins/针数	Code/型	Part number/产品料号
3pins/3孔	A code/A型	12C099
4pins/4孔	A code/A型	12C060
5pins/5孔	A code/A型	12C068
8pins/8孔	A code/A型	12C101
12pins/12孔	A code/A型	12C091
17pins/17孔	A code/A型	12C120

Pin assignment front view/孔位分布前视图

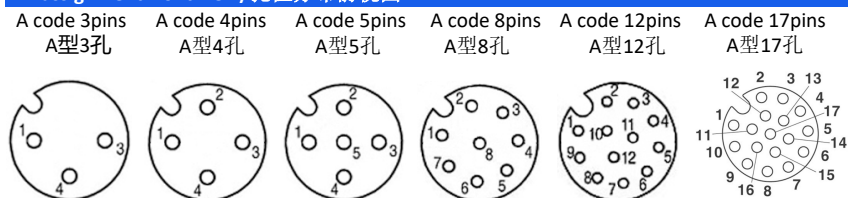

General data/常规数据

Pin Numbers/孔数	3pins/3孔	4pins/4孔	5pins/5孔	8pins/8孔	12pins/12孔	17pins/17孔
Rated voltage/额定电压	250V		60V	30V		
Rated current(40°C)/额定电流	4A			2A	1.5A	1.5A
Standards/标准	IEC 61076-2-101					
Termination/焊接方式	Solder/焊接					
Connector locking system	Screw/螺锁					
Degree of protection/防护等级	IP67, IP68, IP69K					
Wire gauge(mm²)/线规(平方数)	0.14mm²-0.75mm²					
Wire gauge(AWG)/线号(平方数)	26AWG-18AWG					
Mechanical operation/插拔次数	>100 mating cycles/大于100次					
Ambient temperature (operation)/操作温度	-25°C~+85°C					
Contact resistance/接触电阻	≤5mΩ					
Insulation resistance/绝缘电阻	≥100MΩ					
Connector body/胶芯	TPU					
Pin/端子	Phosphorus copper with gold plated/磷铜镀金					
Screw/螺丝	Brass with nickel plated/黄铜镀镍					
Gasket/胶圈	Fluorine ring/氟胶圈					
Customs tariff number/海关编码	8538900000					
Environmental compliance/环境符合标准	RoHs, Reach					

M12 A code male moldable connector with shielded/M12, A型公头成型式连接器, 带屏蔽

Scale drawing/尺寸图

Product photo/产品图

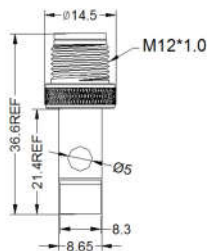

Part number/产品料号

Pins/针数	Code/型	Part number/产品料号
3pins/3针	A code/A型	12C102
4pins/4针	A code/A型	12C104
5pins/5针	A code/A型	12C106
8pins/8针	A code/A型	12C111
12pins/12针	A code/A型	12C109
17pins/17针	A code/A型	12C121

Pin assignment front view/针位分布前视图

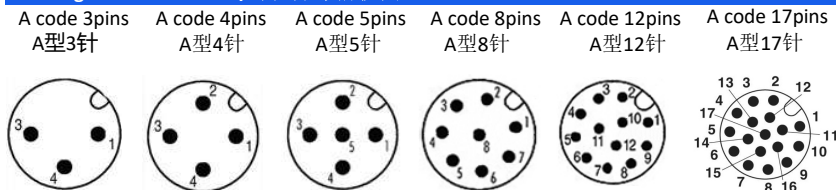

General data/常规数据

Pin Numbers/针数	3pins/3针	4pins/4针	5pins/5针	8pins/8针	12pins/12针	17pins/17针
Rated voltage/额定电压	250V		60V	30V		
Rated current(40°C)/额定电流	4A			2A	1.5A	1.5A
Standards/标准	IEC 61076-2-101					
Termination/焊接方式	Solder/焊接					
Connector locking system	Screw/螺锁					
Degree of protection/防护等级	IP67, IP68, IP69K					
Wire gauge(mm²)/线规(平方数)	0.14mm²-0.75mm²					
Wire gauge(AWG)/线号(平方数)	26AWG-18AWG					
Mechanical operation/插拔次数	>100 mating cycles/大于100次					
Ambient temperature (operation)/操作温度	-25°C~+85°C					
Contact resistance/接触电阻	≤5mΩ					
Insulation resistance/绝缘电阻	≥100MΩ					
Connector body/胶芯	TPU					
Pin/端子	Brass with gold plated/黄铜镀金					
Screw/螺丝	Brass with nickel plated/黄铜镀镍					
Shielded shell/屏蔽罩	Brass with nickel plated/黄铜镀镍					
Customs tariff number/海关编码	8538900000					
Environmental compliance/环境符合标准	RoHs, Reach					

M12 A code female moldable connector with shielded/M12, A型母头成型式连接器, 带屏蔽

Scale drawing/尺寸图

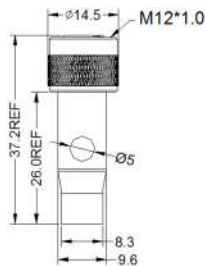

Product photo/产品图



Part number/产品料号

Pins/针数	Code/型	Part number/产品料号
3pins/3孔	A code/A型	12C103
4pins/4孔	A code/A型	12C105
5pins/5孔	A code/A型	12C110
8pins/8孔	A code/A型	12C112
12pins/12孔	A code/A型	12C113
17pins/17孔	A code/A型	12C122

Pin assignment front view/孔位分布前视图

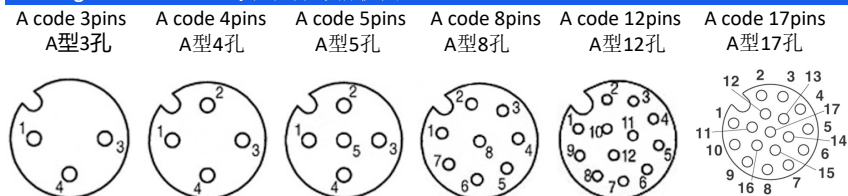

General data/常规数据

Pin Numbers/孔数	3pins/3孔	4pins/4孔	5pins/5孔	8pins/8孔	12pins/12孔	17pins/17孔
Rated voltage/额定电压	250V		60V	30V		
Rated current(40°C)/额定电流	4A			2A	1.5A	1.5A
Standards/标准	IEC 61076-2-101					
Termination/焊接方式	Solder/焊接					
Degree of protection/防护等级	IP67, IP68, IP69K					
Wire gauge(mm²)/线规(平方数)	0.14mm²-0.75mm²					
Wire gauge(AWG)/线号(平方数)	26AWG-18AWG					
Mechanical operation/插拔次数	>100 mating cycles/大于100次					
Ambient temperature (operation)/操作温度	-25°C~+85°C					
Contact resistance/接触电阻	≤5mΩ					
Insulation resistance/绝缘电阻	≥100MΩ					
Connector body/胶芯	TPU					
Pin/端子	Phosphorus copper with gold plated/磷铜镀金					
Screw/螺丝	Brass with nickel plated/黄铜镀镍					
Shielded shell/屏蔽罩	Brass with nickel plated/黄铜镀镍					
Gasket/胶圈	Fluorine ring/氟胶圈					
Customs tariff number/海关编码	8538900000					
Environmental compliance/环境符合标准	RoHS, Reach					

M12 A code male straight front panel mount connector, unshielded, insert/M12, A型公头直头前锁面板板端, 不带屏蔽

Scale drawing/尺寸图

Product photo/产品图

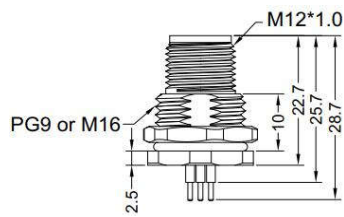

Part number/产品料号

Pins/针数	Code/型	Part number/产品料号	
		PG9 thread 15.3±0.1/PG9螺纹15.3±0.1	M16 thread 16±0.1/M16螺纹16±0.1
3pins/3针	A code/A型	12B001	12B021
4pins/4针	A code/A型	12B005	12B025
5pins/5针	A code/A型	12B009	12B029
8pins/8针	A code/A型	12B013	12B033
12pins/12针	A code/A型	12B017	12B037
17pins/17针	A code/A型	12B173	12B177

Pin assignment front view/针位分布前视图

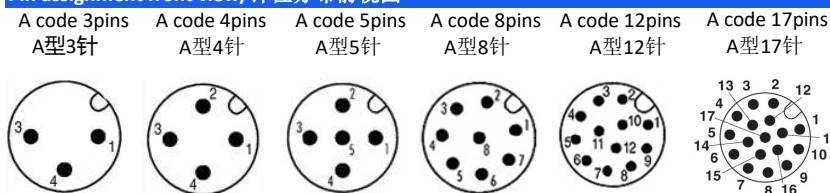

General data/常规数据

Pin Numbers/针数	3pins/3针	4pins/4针	5pins/5针	8pins/8针	12pins/12针	17pins/17针
Rated voltage/额定电压	250V		60V	30V		
Rated current(40°C)/额定电流	4A			2A	1.5A	1.5A
Standards/标准	IEC 61076-2-101					
Termination/焊接方式	Solder PCB/PCB焊接					
Connector locking system/锁紧方式	Screw/螺锁					
Degree of protection/防护等级	IP67, IP68, IP69K					
Mechanical operation/插拔次数	>100 mating cycles/大于100次					
Ambient temperature (operation)/操作温度	-25°C~+85°C					
Contact resistance/接触电阻	≤5mΩ					
Insulation resistance/绝缘电阻	≥100MΩ					
Connector body/胶芯	TPU					
Pin/端子	Brass with gold plated/黄铜镀金					
Nut and shell/螺母和铜壳	Brass with nickel plated/黄铜镀镍					
Gasket/胶圈	Fluorine ring/氟胶圈					
Customs tariff number/海关编码	8538900000					
Environmental compliance/环境符合标准	RoHs, Reach					

M12 A code female straight front panel mount connector, unshielded, insert/M12, A型母头直头前锁面板板端, 不带屏蔽

Scale drawing/尺寸图

Product photo/产品图

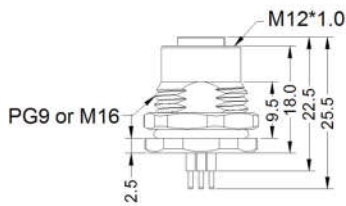

Part number/产品料号

Pins/孔数	Code/型	Part number/产品料号	
		PG9 thread 15.3±0.1/PG9螺纹15.3±0.1	M16 thread 16±0.1/M16螺纹16±0.1
3pins/3孔	A code/A型	12B003	12B023
4pins/4孔	A code/A型	12B007	12B027
5pins/5孔	A code/A型	12B011	12B031
8pins/8孔	A code/A型	12B015	12B035
12pins/12孔	A code/A型	12B019	12B039
17pins/17孔	A code/A型	12B175	12B179

Pin assignment front view/孔位分布前视图

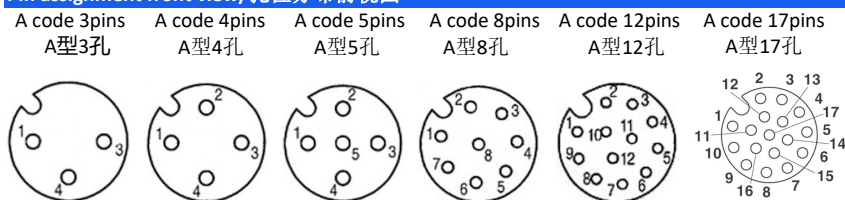

General data/常规数据

Pin Numbers/孔数	3pins/3孔	4pins/4孔	5pins/5孔	8pins/8孔	12pins/12孔	17pins/17孔
Rated voltage/额定电压	250V		60V	30V		
Rated current(40°C)/额定电流	4A			2A	1.5A	1.5A
Standards/标准	IEC 61076-2-101					
Termination/焊接方式	Solder PCB/PCB焊接					
Connector locking system/锁紧方式	Screw/锁紧					
Degree of protection/防护等级	IP67, IP68, IP69K					
Mechanical operation/插拔次数	>100 mating cycles/大于100次					
Ambient temperature (operation)/操作温度	-25°C~+85°C					
Contact resistance/接触电阻	≤5mΩ					
Insulation resistance/绝缘电阻	≥100MΩ					
Connector body/胶芯	TPU					
Pin/端子	Phosphorus copper with gold plated/磷铜镀金					
Nut and shell/螺母和铜壳	Brass with nickel plated/黄铜镀镍					
Gasket/胶圈	Fluorine ring/氟胶圈					
Customs tariff number/海关编码	8538900000					
Environmental compliance/环境符合标准	RoHs, Reach					

M12 A code male straight rear panel mount connector, unshielded, insert/M12, A型公头直头后锁面板板端, 不带屏蔽

Scale drawing/尺寸图

Product photo/产品图

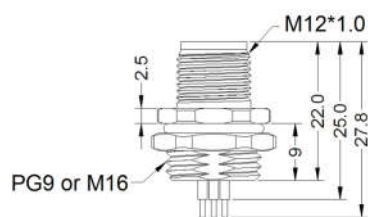

Part number/产品料号

Pins/针数	Code/型	Part number/产品料号	
		PG9 thread 15.3±0.1/PG9螺纹15.3±0.1	M16 thread 16±0.1/M16螺纹16±0.1
3pins/3针	A code/A型	12B002	12B022
4pins/4针	A code/A型	12B006	12B026
5pins/5针	A code/A型	12B010	12B030
8pins/8针	A code/A型	12B014	12B034
12pins/12针	A code/A型	12B018	12B038
17pins/17针	A code/A型	12B174	12B178

Pin assignment front view/针位分布前视图

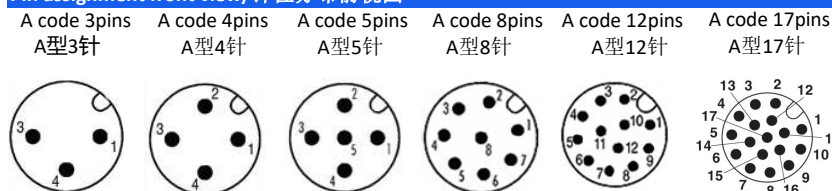

General data/常规数据

Pin Numbers/针数	3pins/3针	4pins/4针	5pins/5针	8pins/8针	12pins/12针	17pins/17针
Rated voltage/额定电压	250V		60V	30V		
Rated current(40°C)/额定电流	4A			2A	1.5A	1.5A
Standards/标准	IEC 61076-2-101					
Termination/焊接方式	Solder PCB/PCB焊接					
Connector locking system/锁紧方式	Screw/锁紧					
Degree of protection/防护等级	IP67, IP68, IP69K					
Mechanical operation/插拔次数	>100 mating cycles/大于100次					
Ambient temperature (operation)/操作温度	-25°C~+85°C					
Contact resistance/接触电阻	≤5mΩ					
Insulation resistance/绝缘电阻	≥100MΩ					
Connector body/胶芯	TPU					
Pin/端子	Brass with gold plated/黄铜镀金					
Nut and shell/螺母和铜壳	Brass with nickel plated/黄铜镀镍					
Gasket/胶圈	Fluorine ring/氟胶圈					
Customs tariff number/海关编码	8538900000					
Environmental compliance/环境符合标准	RoHs, Reach					

M12 A code female straight rear panel mount connector, unshielded, insert/M12, A型母头直头后锁面板板端, 不带屏蔽

Scale drawing/尺寸图

Product photo/产品图

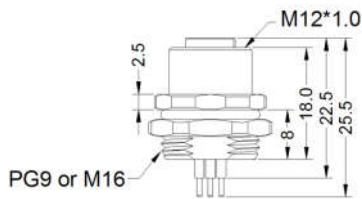

Part number/产品料号

Pins/孔数	Code/型	Part number/产品料号	
		PG9 thread 15.3±0.1/PG9螺纹15.3±0.1	M16 thread 16±0.1/M16螺纹16±0.1
3pins/3孔	A code/A型	12B004	12B024
4pins/4孔	A code/A型	12B008	12B028
5pins/5孔	A code/A型	12B012	12B032
8pins/8孔	A code/A型	12B016	12B036
12pins/12孔	A code/A型	12B020	12B040
17pins/17孔	A code/A型	12B176	12B180

Pin assignment front view/孔位分布前视图

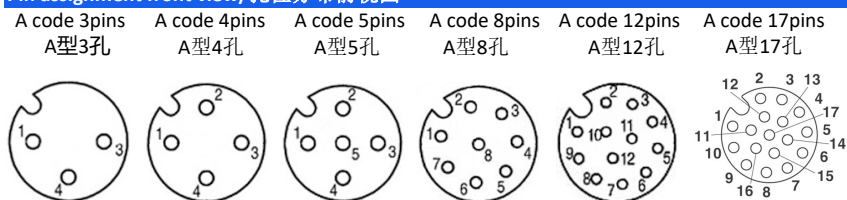

General data/常规数据

Pin Numbers/孔数	3pins/3孔	4pins/4孔	5pins/5孔	8pins/8孔	12pins/12孔	17pins/17孔
Rated voltage/额定电压	250V		60V	30V		
Rated current(40°C)/额定电流	4A			2A	1.5A	1.5A
Standards/标准	IEC 61076-2-101					
Termination/焊接方式	Solder PCB/PCB焊接					
Connector locking system/锁紧方式	Screw/锁紧					
Degree of protection/防护等级	IP67, IP68, IP69K					
Mechanical operation/插拔次数	>100 mating cycles/大于100次					
Ambient temperature (operation)/操作温度	-25°C~+85°C					
Contact resistance/接触电阻	≤5mΩ					
Insulation resistance/绝缘电阻	≥100MΩ					
Connector body/胶芯	TPU					
Pin/端子	Phosphorus copper with gold plated/磷铜镀金					
Nut and shell/螺母和铜壳	Brass with nickel plated/黄铜镀镍					
Gasket/胶圈	Fluorine ring/氟胶圈					
Customs tariff number/海关编码	8538900000					
Environmental compliance/环境符合标准	RoHs, Reach					

M12 A code male right angle front panel mount connector, unshielded, insert/M12, A型公头弯头前锁面板板端, 不带屏蔽

Scale drawing/尺寸图

Product photo/产品图

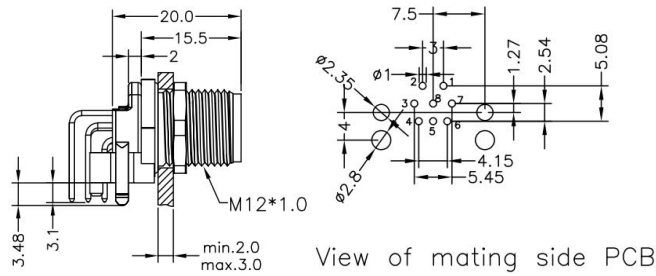

Part number/产品料号

Pins/针数	Code/型	Part number/产品料号
3pins/3针	A code/A型	12B065
4pins/4针	A code/A型	12B067
5pins/5针	A code/A型	12B069
8pins/8针	A code/A型	12B081
12pins/12针	A code/A型	12B073

Pin assignment front view/针位分布前视图

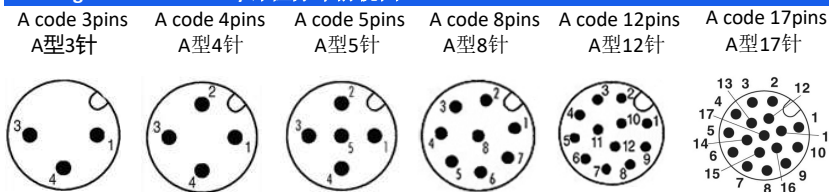

General data/常规数据

Pin Numbers/针数	3pins/3针	4pins/4针	5pins/5针	8pins/8针	12pins/12针
Rated voltage/额定电压	250V	250V	60V	30V	30V
Rated current(40°C)/额定电流	4A	4A	4A	2A	1.5A
Standards/标准	IEC 61076-2-101				
Termination/焊接方式	Solder PCB/PCB焊接				
Connector locking system/锁紧方式	Screw/螺锁				
Degree of protection/防护等级	IP67, IP68, IP69K				
Mechanical operation/插拔次数	>100 mating cycles/大于100次				
Ambient temperature (operation)/操作温度	-25°C~+85°C				
Contact resistance/接触电阻	≤5mΩ				
Insulation resistance/绝缘电阻	≥100MΩ				
Connector body/胶芯	TPU				
Pin/端子	Brass with gold plated/黄铜镀金				
Nut and shell/螺母和铜壳	Brass with nickel plated/黄铜镀镍				
Gasket/胶圈	Fluorine ring/氟胶圈				
Customs tariff number/海关编码	8538900000				
Environmental compliance/环境符合标准	RoHS, Reach				

M12 A code female right angle front panel mount connector, unshielded, insert/M12, A型母头弯头前锁面板板端, 不带屏蔽

Scale drawing/尺寸图

Product photo/产品图

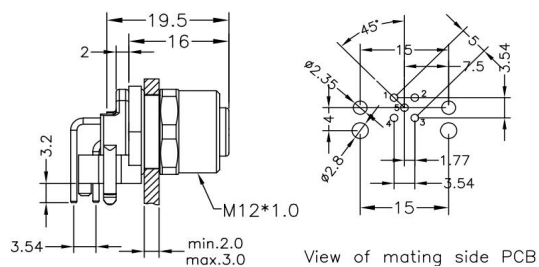

Part number/产品料号

Pins/针数	Code/型	Part number/产品料号
3pins/3孔	A code/A型	12B066
4pins/4孔	A code/A型	12B068
5pins/5孔	A code/A型	12B070
8pins/8孔	A code/A型	12B072
12pins/12孔	A code/A型	12B074

Pin assignment front view/孔位分布前视图

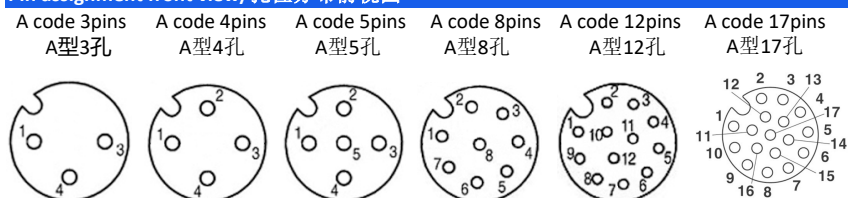

General data/常规数据

Pin Numbers/孔数	3pins/3孔	4pins/4孔	5pins/5孔	8pins/8孔	12pins/12孔
Rated voltage/额定电压	250V	250V	60V	30V	30V
Rated current(40°C)/额定电流	4A	4A	4A	2A	1.5A
Standards/标准	IEC 61076-2-101				
Termination/焊接方式	Solder PCB/PCB焊接				
Connector locking system/锁紧方式	Screw/螺锁				
Degree of protection/防护等级	IP67, IP68, IP69K				
Mechanical operation/插拔次数	>100 mating cycles/大于100次				
Ambient temperature (operation)/操作温度	-25°C~+85°C				
Contact resistance/接触电阻	≤5mΩ				
Insulation resistance/绝缘电阻	≥100MΩ				
Connector body/胶芯	TPU				
Pin/端子	Phosphorus copper with gold plated/磷铜镀金				
Nut and shell/螺母和铜壳	Brass with nickel plated/黄铜镀镍				
Gasket/胶圈	Fluorine ring/氟胶圈				
Customs tariff number/海关编码	8538900000				
Environmental compliance/环境符合标准	RoHS, Reach				

M12 A code male straight front panel mount connector, unshielded, insert/M12, A型公头直头前锁面板焊线式, 不带屏蔽

Scale drawing/尺寸图

Product photo/产品图

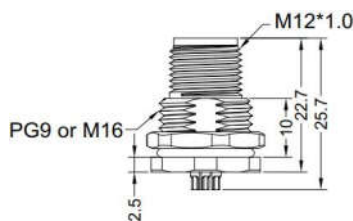

Part number/产品料号

Pins/针数	Code/型	Part number/产品料号	
		PG9 thread 15.3±0.1/PG9螺纹15.3±0.1	M16 thread 16±0.1/M16螺纹16±0.1
3pins/3针	A code/A型	12H001	12H021
4pins/4针	A code/A型	12H005	12H025
5pins/5针	A code/A型	12H009	12H029
8pins/8针	A code/A型	12H013	12H033
12pins/12针	A code/A型	12H017	12H037
17pins/17针	A code/A型	12H095	12H099

Pin assignment front view/针位分布前视图

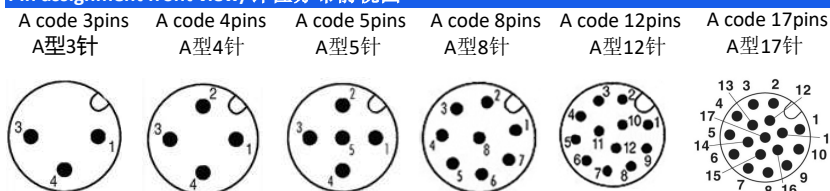

General data/常规数据

Pin Numbers/针数	3pins/3针	4pins/4针	5pins/5针	8pins/8针	12pins/12针	17pins/17针
Rated voltage/额定电压	250V		60V	30V		
Rated current(40°C)/额定电流	4A			2A	1.5A	1.5A
Standards/标准	IEC 61076-2-101					
Termination/焊接方式	Solder wires/焊线					
Connector locking system/锁紧方式	Screw/螺锁					
Degree of protection/防护等级	IP67, IP68, IP69K					
Mechanical operation/插拔次数	>100 mating cycles/大于100次					
Ambient temperature (operation)/操作温度	-25°C~+85°C					
Contact resistance/接触电阻	≤5mΩ					
Insulation resistance/绝缘电阻	≥100MΩ					
Connector body/胶芯	TPU					
Pin/端子	Brass with gold plated/黄铜镀金					
Nut and shell/螺母和铜壳	Brass with nickel plated/黄铜镀镍					
Gasket/胶圈	Fluorine ring/氟胶圈					
Customs tariff number/海关编码	8538900000					
Environmental compliance/环境符合标准	RoHs, Reach					

M12 A code female straight front panel mount connector, unshielded, insert/M12, A型母头直头前锁面板焊线式, 不带屏蔽

Scale drawing/尺寸图

Product photo/产品图

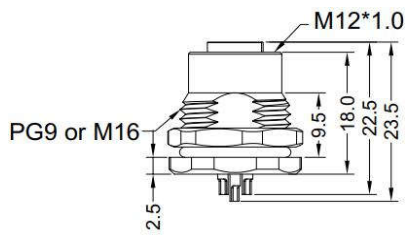

Part number/产品料号

Pins/孔数	Code/型	Part number/产品料号	
		PG9 thread 15.3±0.1/PG9螺纹15.3±0.1	M16 thread 16±0.1/M16螺纹16±0.1
3pins/3孔	A code/A型	12H003	12H023
4pins/4孔	A code/A型	12H007	12H027
5pins/5孔	A code/A型	12H011	12H031
8pins/8孔	A code/A型	12H134	12H035
12pins/12孔	A code/A型	12H019	12H039
17pins/17孔	A code/A型	12H097	12H101

Pin assignment front view/孔位分布前视图

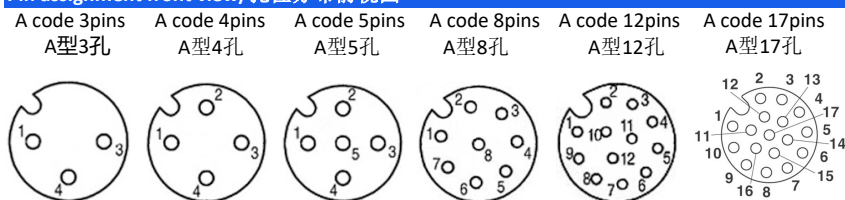

General data/常规数据

Pin Numbers/孔数	3pins/3孔	4pins/4孔	5pins/5孔	8pins/8孔	12pins/12孔	17pins/17孔
Rated voltage/额定电压	250V		60V	30V		
Rated current(40°C)/额定电流	4A			2A	1.5A	1.5A
Standards/标准	IEC 61076-2-101					
Termination/焊接方式	Solder wires/焊线					
Connector locking system/锁紧方式	Screw/锁紧					
Degree of protection/防护等级	IP67, IP68, IP69K					
Mechanical operation/插拔次数	>100 mating cycles/大于100次					
Ambient temperature (operation)/操作温度	-25°C~+85°C					
Contact resistance/接触电阻	≤5mΩ					
Insulation resistance/绝缘电阻	≥100MΩ					
Connector body/胶芯	TPU					
Pin/端子	Phosphorus copper with gold plated/磷铜镀金					
Nut and shell/螺母和铜壳	Brass with nickel plated/黄铜镀镍					
Gasket/胶圈	Fluorine ring/氟胶圈					
Customs tariff number/海关编码	8538900000					
Environmental compliance/环境符合标准	RoHs, Reach					

M12 A code male straight rear panel mount connector, unshielded, insert/M12, A型公头直头后锁面板焊线式, 不带屏蔽

Scale drawing/尺寸图

Product photo/产品图

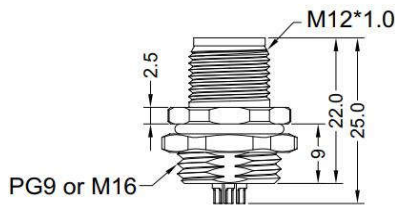

Part number/产品料号

Pins/针数	Code/型	Part number/产品料号	
		PG9 thread 15.3±0.1/PG9螺纹15.3±0.1	M16 thread 16±0.1/M16螺纹16±0.1
3pins/3针	A code/A型	12H002	12H022
4pins/4针	A code/A型	12H006	12H026
5pins/5针	A code/A型	12H010	12H030
8pins/8针	A code/A型	12H014	12H034
12pins/12针	A code/A型	12H018	12H038
17pins/17针	A code/A型	12H096	12H100

Pin assignment front view/针位分布前视图

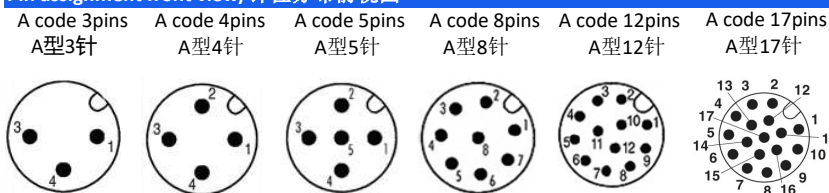

General data/常规数据

Pin Numbers/针数	3pins/3针	4pins/4针	5pins/5针	8pins/8针	12pins/12针	17pins/17针
Rated voltage/额定电压	250V		60V	30V		
Rated current(40°C)/额定电流	4A			2A	1.5A	1.5A
Standards/标准	IEC 61076-2-101					
Termination/焊接方式	Solder wires/焊线					
Connector locking system/锁紧方式	Screw/锁紧					
Degree of protection/防护等级	IP67, IP68, IP69K					
Mechanical operation/插拔次数	>100 mating cycles/大于100次					
Ambient temperature (operation)/操作温度	-25°C~+85°C					
Contact resistance/接触电阻	≤5mΩ					
Insulation resistance/绝缘电阻	≥100MΩ					
Connector body/胶芯	TPU					
Pin/端子	Brass with gold plated/黄铜镀金					
Nut and shell/螺母和铜壳	Brass with nickel plated/黄铜镀镍					
Gasket/胶圈	Fluorine ring/氟胶圈					
Customs tariff number/海关编码	8538900000					
Environmental compliance/环境符合标准	RoHs, Reach					

M12 A code female straight rear panel mount connector, unshielded, insert/M12, A型母头直头后锁面板焊线式, 不带屏蔽

Scale drawing/尺寸图

Product photo/产品图

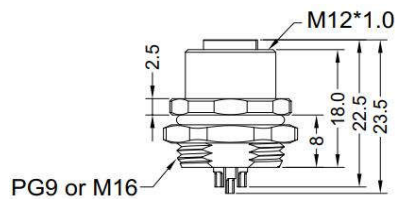

Part number/产品料号

Pins/孔数	Code/型	Part number/产品料号	
		PG9 thread 15.3±0.1/PG9螺纹15.3±0.1	M16 thread 16±0.1/M16螺纹16±0.1
3pins/3孔	A code/A型	12H004	12H024
4pins/4孔	A code/A型	12H008	12H028
5pins/5孔	A code/A型	12H012	12H032
8pins/8孔	A code/A型	12H016	12H036
12pins/12孔	A code/A型	12H020	12H040
17pins/17孔	A code/A型	12H098	12H102

Pin assignment front view/孔位分布前视图

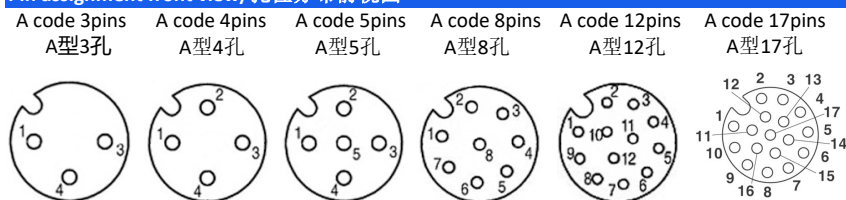

General data/常规数据

Pin Numbers/孔数	3pins/3孔	4pins/4孔	5pins/5孔	8pins/8孔	12pins/12孔	17pins/17孔
Rated voltage/额定电压	250V		60V	30V		
Rated current(40°C)/额定电流	4A			2A	1.5A	1.5A
Standards/标准	IEC 61076-2-101					
Termination/焊接方式	Solder wires/焊线					
Connector locking system/锁紧方式	Screw/锁紧					
Degree of protection/防护等级	IP67, IP68, IP69K					
Mechanical operation/插拔次数	>100 mating cycles/大于100次					
Ambient temperature (operation)/操作温度	-25°C~+85°C					
Contact resistance/接触电阻	≤5mΩ					
Insulation resistance/绝缘电阻	≥100MΩ					
Connector body/胶芯	TPU					
Pin/端子	Phosphorus copper with gold plated/磷铜镀金					
Nut and shell/螺母和铜壳	Brass with nickel plated/黄铜镀镍					
Gasket/胶圈	Fluorine ring/氟胶圈					
Customs tariff number/海关编码	8538900000					
Environmental compliance/环境符合标准	RoHs, Reach					

M12 A code male straight front panel mount connector, unshielded, single wires/M12, A型公头直头前锁面板带线, 不带屏蔽

Scale drawing/尺寸图

Product photo/产品图

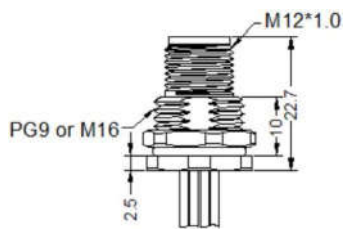

Part number/产品料号

Pins/针数	Code/型	Part number("X" is length millimetre mm)/产品料号("X"表示长度, 单位毫米mm)	
		PG9 thread 15.3±0.1/PG9螺纹15.3±0.1	M16 thread 16±0.1/M16螺纹16±0.1
3pins/3针	A code/A型	12D001-X	12D021-X
4pins/4针	A code/A型	12D005-X	12D025-X
5pins/5针	A code/A型	12D009-X	12D029-X
8pins/8针	A code/A型	12D013-X	12D033-X
12pins/12针	A code/A型	12D017-X	12D037-X
17pins/17针	A code/A型	12D266-X	12D267-X

Pin assignment front view/针位分布前视图

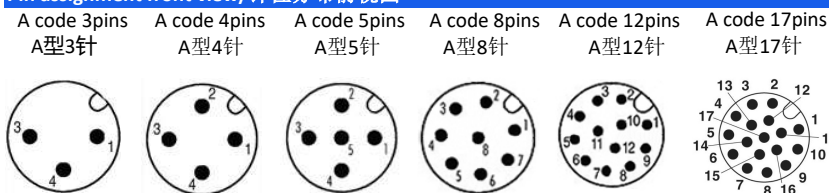

General data/常规数据

Pin Numbers/针数	3pins/3针	4pins/4针	5pins/5针	8pins/8针	12pins/12针	17pins/17针
Rated voltage/额定电压	250V		60V	30V		
Rated current(40°C)/额定电流	4A			2A	1.5A	1.5A
Standards/标准	IEC 61076-2-101					
Termination/焊接方式	Solder/焊接					
Connector locking system/锁紧方式	Screw/锁紧					
Degree of protection/防护等级	IP67, IP68, IP69K					
Wire gauge(mm²)/线规(平方数)	0.14mm²-0.75mm²					
Wire gauge(AWG)/线号(平方数)	26AWG-18AWG					
Mechanical operation/插拔次数	>100 mating cycles/大于100次					
Ambient temperature (operation)/操作温度	-40°C~+85°C					
Contact resistance/接触电阻	≤5mΩ					
Insulation resistance/绝缘电阻	≥100MΩ					
Connector body/胶芯	TPU					
Pin/端子	Brass with gold plated/黄铜镀金					
Nut and shell/螺母和铜壳	Brass with nickel plated/黄铜镀镍					
Gasket/胶圈	Fluorine ring/氟胶圈					
Customs tariff number/海关编码	8538900000					
Environmental compliance/环境符合标准	RoHS, Reach					

M12 A code female straight front panel mount connector, unshielded, single wires/M12, A型母头直头前锁面板带线, 不带屏蔽

Scale drawing/尺寸图

Product photo/产品图

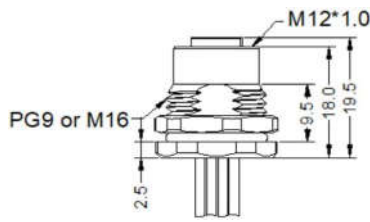

Part number/产品料号

Pins/针数	Code/型	Part number("X" is length millimetre mm)/产品料号("X"表示长度, 单位毫米mm)	
		PG9 thread 15.3±0.1/PG9螺纹15.3±0.1	M16 thread 16±0.1/M16螺纹16±0.1
3pins/3孔	A code/A型	12D003-X	12D023-X
4pins/4孔	A code/A型	12D007-X	12D027-X
5pins/5孔	A code/A型	12D011-X	12D031-X
8pins/8孔	A code/A型	12D015-X	12D035-X
12pins/12孔	A code/A型	12D019-X	12D039-X
17pins/17孔	A code/A型	12D268-X	12D270-X

Pin assignment front view/孔位分布前视图

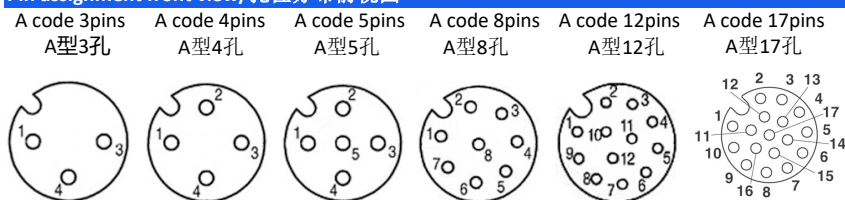

General data/常规数据

Pin Numbers/孔数	3pins/3孔	4pins/4孔	5pins/5孔	8pins/8孔	12pins/12孔	17pins/17孔
Rated voltage/额定电压	250V		60V	30V		
Rated current(40°C)/额定电流	4A			2A	1.5A	1.5A
Standards/标准	IEC 61076-2-101					
Termination/焊接方式	Solder/焊接					
Connector locking system/锁紧方式	Screw/锁紧					
Degree of protection/防护等级	IP67, IP68, IP69K					
Wire gauge(mm²)/线规(平方数)	0.14mm²-0.75mm²					
Wire gauge(AWG)/线号(平方数)	26AWG-18AWG					
Mechanical operation/插拔次数	>100 mating cycles/大于100次					
Ambient temperature (operation)/操作温度	-40°C~+85°C					
Contact resistance/接触电阻	≤5mΩ					
Insulation resistance/绝缘电阻	≥100MΩ					
Connector body/胶芯	TPU					
Pin/端子	Phosphorus copper with gold plated/磷铜镀金					
Nut and shell/螺母和铜壳	Brass with nickel plated/黄铜镀镍					
Gasket/胶圈	Fluorine ring/氟胶圈					
Customs tariff number/海关编码	8538900000					
Environmental compliance/环境符合标准	RoHS, Reach					

M12 A code male straight rear panel mount connector, unshielded, single wires/M12, A型公头直头后锁面板带线, 不带屏蔽

Scale drawing/尺寸图

Product photo/产品图

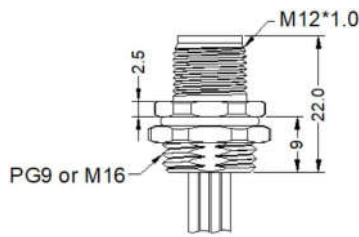

Part number/产品料号

Pins/针数	Code/型	Part number("X" is length millimetre mm)/产品料号("X"表示长度, 单位毫米mm)	
		PG9 thread 15.3±0.1/PG9螺纹15.3±0.1	M16 thread 16±0.1/M16螺纹16±0.1
3pins/3针	A code/A型	12D002-X	12D022-X
4pins/4针	A code/A型	12D006-X	12D026-X
5pins/5针	A code/A型	12D010-X	12D030-X
8pins/8针	A code/A型	12D014-X	12D034-X
12pins/12针	A code/A型	12D018-X	12D038-X
17pins/17针	A code/A型	12D272-X	12D273-X

Pin assignment front view/针位分布前视图

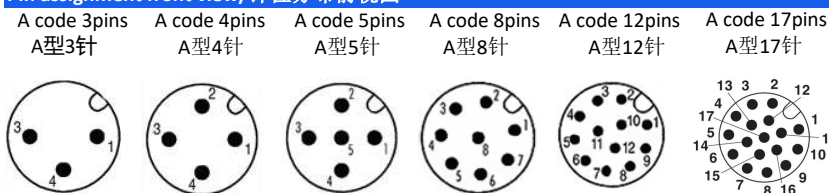

General data/常规数据

Pin Numbers/针数	3pins/3针	4pins/4针	5pins/5针	8pins/8针	12pins/12针	17pins/17针
Rated voltage/额定电压	250V		60V	30V		
Rated current(40°C)/额定电流	4A			2A	1.5A	1.5A
Standards/标准	IEC 61076-2-101					
Termination/焊接方式	Solder/焊接					
Connector locking system/锁紧方式	Screw/锁紧					
Degree of protection/防护等级	IP67, IP68, IP69K					
Wire gauge(mm²)/线规(平方数)	0.14mm²-0.75mm²					
Wire gauge(AWG)/线号(平方数)	26AWG-18AWG					
Mechanical operation/插拔次数	>100 mating cycles/大于100次					
Ambient temperature (operation)/操作温度	-40°C~+85°C					
Contact resistance/接触电阻	≤5mΩ					
Insulation resistance/绝缘电阻	≥100MΩ					
Connector body/胶芯	TPU					
Pin/端子	Brass with gold plated/黄铜镀金					
Nut and shell/螺母和铜壳	Brass with nickel plated/黄铜镀镍					
Gasket/胶圈	Fluorine ring/氟胶圈					
Customs tariff number/海关编码	8538900000					
Environmental compliance/环境符合标准	RoHS, Reach					

M12 A code female straight rear panel mount connector, unshielded, single wires/M12, A型母头直头后锁面板带线, 不带屏蔽

Scale drawing/尺寸图

Product photo/产品图

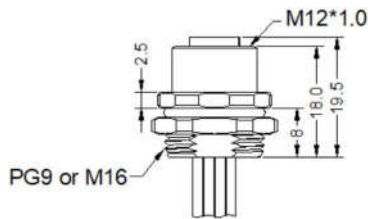

Part number/产品料号

Pins/针数	Code/型	Part number("X" is length millimetre mm)/产品料号("X"表示长度, 单位毫米mm)	
		PG9 thread 15.3±0.1/PG9螺纹15.3±0.1	M16 thread 16±0.1/M16螺纹16±0.1
3pins/3孔	A code/A型	12D004-X	12D024-X
4pins/4孔	A code/A型	12D008-X	12D028-X
5pins/5孔	A code/A型	12D012-X	12D032-X
8pins/8孔	A code/A型	12D016-X	12D036-X
12pins/12孔	A code/A型	12D020-X	12D040-X
17pins/17孔	A code/A型	12D269-X	12D271-X

Pin assignment front view/孔位分布前视图

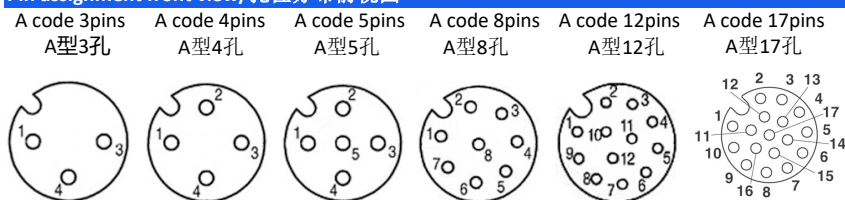

General data/常规数据

Pin Numbers/孔数	3pins/3孔	4pins/4孔	5pins/5孔	8pins/8孔	12pins/12孔	17pins/17孔
Rated voltage/额定电压	250V		60V	30V		
Rated current(40°C)/额定电流	4A			2A	1.5A	1.5A
Standards/标准	IEC 61076-2-101					
Termination/焊接方式	Solder/焊接					
Connector locking system/锁紧方式	Screw/锁紧					
Degree of protection/防护等级	IP67, IP68, IP69K					
Wire gauge(mm²)/线规(平方数)	0.14mm²-0.75mm²					
Wire gauge(AWG)/线号(平方数)	26AWG-18AWG					
Mechanical operation/插拔次数	>100 mating cycles/大于100次					
Ambient temperature (operation)/操作温度	-40°C~+85°C					
Contact resistance/接触电阻	≤5mΩ					
Insulation resistance/绝缘电阻	≥100MΩ					
Connector body/胶芯	TPU					
Pin/端子	Phosphorus copper with gold plated/磷铜镀金					
Nut and shell/螺母和铜壳	Brass with nickel plated/黄铜镀镍					
Gasket/胶圈	Fluorine ring/氟胶圈					
Customs tariff number/海关编码	8538900000					
Environmental compliance/环境符合标准	RoHS, Reach					

M12 A code male straight plastic assembly connector, unshielded/M12, A型公头直头塑胶装配式连接器, 不带屏蔽

Scale drawing/尺寸图

Product photo/产品图

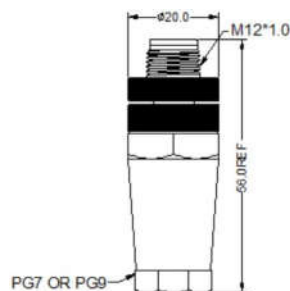

Part number/产品料号

Pins/针数	Code/型	Part number/产品料号	
		PG7 hole/PG7孔	PG9 hole/PG9孔
3pins/3针	A code/A型	12ZU01-PG7	12ZU01-PG9
4pins/4针	A code/A型	12ZU03-PG7	12ZU03-PG9
5pins/5针	A code/A型	12ZU05-PG7	12ZU05-PG9
8pins/8针	A code/A型	12ZU07-PG7	12ZU07-PG9
12pins/12针	A code/A型	12ZU65-PG7	12ZU65-PG9

Pin assignment front view/针位分布前视图

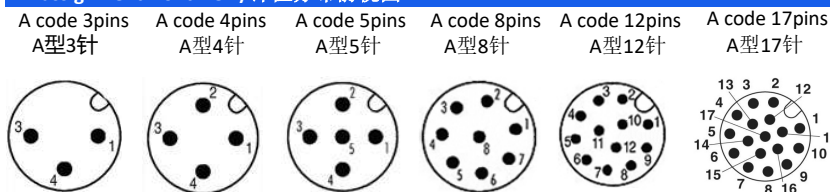

General data/常规数据

Pin Numbers/针数	3pins/3针	4pins/4针	5pins/5针	8pins/8针	12pins/12针
Rated voltage/额定电压	250V	250V	60V	30V	30V
Rated current(40°C)/额定电流	4A	4A	4A	2A	1.5A
Standards/标准	IEC 61076-2-101				
Termination/焊接方式	screw clamp/螺锁				
Degree of protection/防护等级	IP67				
Wire gauge(mm ²)/线规(平方数)	0.14mm ² -0.75mm ²				
Wire gauge(AWG)/线号(平方数)	26AWG-18AWG				
PG7 hole suitable cable outer diameter/PG7孔适合线材外径	4.0mm-6.0mm				
PG9 hole suitable cable outer diameter/PG9孔适合线材外径	6.0mm-8.0mm				
Mechanical operation/插拔次数	>100 mating cycles/大于100次				
Ambient temperature (operation)/操作温度	-25°C~+85°C				
Contact resistance/接触电阻	≤5mΩ				
Insulation resistance/绝缘电阻	≥100MΩ				
Connector body/胶芯	TPU				
Pin/端子	Brass with gold plated/黄铜镀金				
Screw/螺丝	Brass with nickel plated/黄铜镀镍				
Gasket/胶圈	Fluorine ring/氟胶圈				
Customs tariff number/海关编码	8538900000				
Environmental compliance/环境符合标准	RoHs, Reach				

M12 A code female straight plastic assembly connector, unshielded/M12, A型母头直头塑胶装配式连接器, 不带屏蔽

Scale drawing/尺寸图

Product photo/产品图

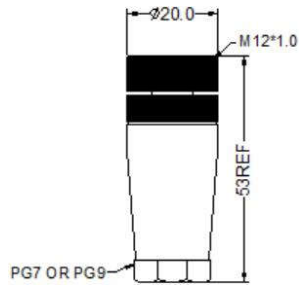

Part number/产品料号

Pins/针数	Code/型	Part number/产品料号	
		PG7 hole/PG7孔	PG9 hole/PG9孔
3pins/3孔	A code/A型	12ZU02-PG7	12ZU02-PG9
4pins/4孔	A code/A型	12ZU04-PG7	12ZU04-PG9
5pins/5孔	A code/A型	12ZU06-PG7	12ZU06-PG9
8pins/8孔	A code/A型	12ZU08-PG7	12ZU08-PG9
12pins/12孔	A code/A型	12ZU66-PG7	12ZU66-PG9

Pin assignment front view/孔位分布前视图

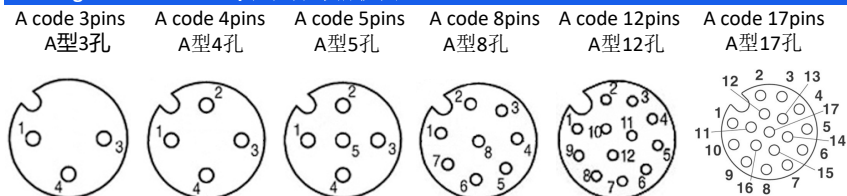

General data/常规数据

Pin Numbers/孔数	3pins/3孔	4pins/4孔	5pins/5孔	8pins/8孔	12pins/12孔
Rated voltage/额定电压	250V	250V	60V	30V	30V
Rated current(40°C)/额定电流	4A	4A	4A	2A	1.5A
Standards/标准	IEC 61076-2-101				
Termination/焊接方式	screw clamp/螺锁				
Degree of protection/防护等级	IP67				
Wire gauge(mm²)/线规(平方数)	0.14mm²-0.75mm²				
Wire gauge(AWG)/线号(平方数)	26AWG-18AWG				
PG7 hole suitable cable outer diameter/PG7孔适合线材外径	4.0mm-6.0mm				
PG9 hole suitable cable outer diameter/PG9孔适合线材外径	6.0mm-8.0mm				
Mechanical operation/插拔次数	>100 mating cycles/大于100次				
Ambient temperature (operation)/操作温度	-25°C~+85°C				
Contact resistance/接触电阻	≤5mΩ				
Insulation resistance/绝缘电阻	≥100MΩ				
Connector body/胶芯	TPU				
Pin/端子	Phosphorus copper with gold plated/磷铜镀金				
Screw/螺丝	Brass with nickel plated/黄铜镀镍				
Gasket/胶圈	Fluorine ring/氟胶圈				
Customs tariff number/海关编码	8538900000				
Environmental compliance/环境符合标准	RoHS, Reach				

M12 A code male right angle plastic assembly connector, unshielded/M12, A型公头弯头塑胶装配式连接器, 不带屏蔽

Scale drawing/尺寸图

Product photo/产品图

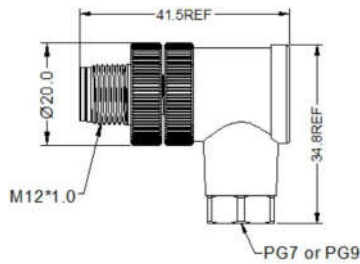

Part number/产品料号

Pins/针数	Code/型	Part number/产品料号	
		PG7 hole/PG7孔	PG9 hole/PG9孔
3pins/3针	A code/A型	12ZU21-PG7	12ZU21-PG9
4pins/4针	A code/A型	12ZU23-PG7	12ZU23-PG9
5pins/5针	A code/A型	12ZU25-PG7	12ZU25-PG9
8pins/8针	A code/A型	12ZU27-PG7	12ZU27-PG9
12pins/12针	A code/A型	12ZU71-PG7	12ZU71-PG9

Pin assignment front view/针位分布前视图

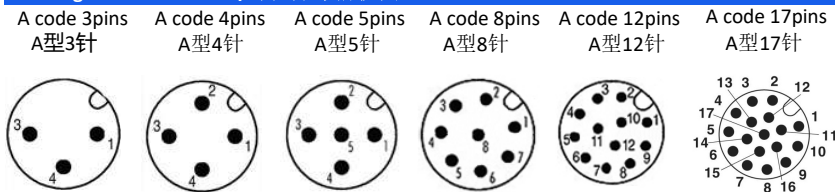

General data/常规数据

Pin Numbers/针数	3pins/3针	4pins/4针	5pins/5针	8pins/8针	12pins/12针
Rated voltage/额定电压	250V	250V	60V	30V	30V
Rated current(40°C)/额定电流	4A	4A	4A	2A	1.5A
Standards/标准	IEC 61076-2-101				
Termination/焊接方式	screw clamp/螺锁				
Degree of protection/防护等级	IP67				
Wire gauge(mm²)/线规(平方数)	0.14mm²-0.75mm²				
Wire gauge(AWG)/线号(平方数)	26AWG-18AWG				
PG7 hole suitable cable outer diameter/PG7孔适合线材外径	4.0mm-6.0mm				
PG9 hole suitable cable outer diameter/PG9孔适合线材外径	6.0mm-8.0mm				
Mechanical operation/插拔次数	>100 mating cycles/大于100次				
Ambient temperature (operation)/操作温度	-25°C~+85°C				
Contact resistance/接触电阻	≤5mΩ				
Insulation resistance/绝缘电阻	≥100MΩ				
Connector body/胶芯	TPU				
Pin/端子	Brass with gold plated/黄铜镀金				
Screw/螺丝	Brass with nickel plated/黄铜镀镍				
Gasket/胶圈	Fluorine ring/氟胶圈				
Customs tariff number/海关编码	8538900000				
Environmental compliance/环境符合标准	RoHS, Reach				

M12 A code female right angle plastic assembly connector, unshielded/M12, A型母头弯头塑胶装配式连接器, 不带屏蔽

Scale drawing/尺寸图

Product photo/产品图

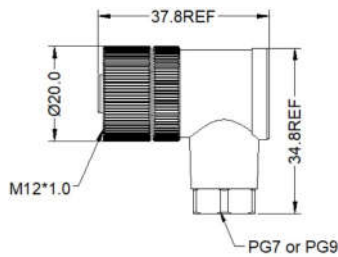

Part number/产品料号

Pins/针数	Code/型	Part number/产品料号	
		PG7 hole/PG7孔	PG9 hole/PG9孔
3pins/3孔	A code/A型	12ZU22-PG7	12ZU22-PG9
4pins/4孔	A code/A型	12ZU24-PG7	12ZU24-PG9
5pins/5孔	A code/A型	12ZU26-PG7	12ZU26-PG9
8pins/8孔	A code/A型	12ZU28-PG7	12ZU28-PG9
12pins/12孔	A code/A型	12ZU72-PG7	12ZU72-PG9

Pin assignment front view/孔位分布前视图

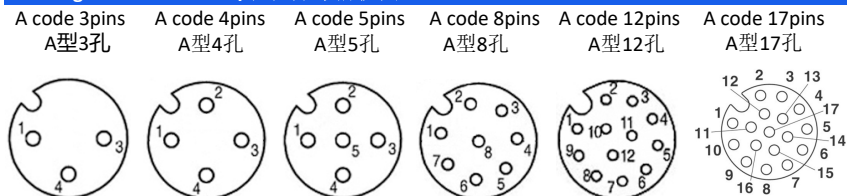

General data/常规数据

Pin Numbers/孔数	3pins/3孔	4pins/4孔	5pins/5孔	8pins/8孔	12pins/12孔
Rated voltage/额定电压	250V	250V	60V	30V	30V
Rated current(40°C)/额定电流	4A	4A	4A	2A	1.5A
Standards/标准	IEC 61076-2-101				
Termination/焊接方式	screw clamp/螺锁				
Degree of protection/防护等级	IP67				
Wire gauge(mm²)/线规(平方数)	0.14mm²-0.75mm²				
Wire gauge(AWG)/线号(平方数)	26AWG-18AWG				
PG7 hole suitable cable outer diameter/PG7孔适合线材外径	4.0mm-6.0mm				
PG9 hole suitable cable outer diameter/PG9孔适合线材外径	6.0mm-8.0mm				
Mechanical operation/插拔次数	>100 mating cycles/大于100次				
Ambient temperature (operation)/操作温度	-25°C~+85°C				
Contact resistance/接触电阻	≤5mΩ				
Insulation resistance/绝缘电阻	≥100MΩ				
Connector body/胶芯	TPU				
Pin/端子	Phosphorus copper with gold plated/磷铜镀金				
Screw/螺丝	Brass with nickel plated/黄铜镀镍				
Gasket/胶圈	Fluorine ring/氟胶圈				
Customs tariff number/海关编码	8538900000				
Environmental compliance/环境符合标准	RoHS, Reach				

M12 A code male straight metal assembly connector with shielded/M12, A型公头直头金属装配式连接器, 带屏蔽

Scale drawing/尺寸图

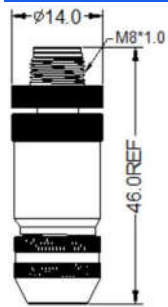

Product photo/产品图



Part number/产品料号

Pins/针数	Code/型	Part number/产品料号	
		PG7 hole/PG7孔	PG9 hole/PG9孔
3pins/3针	A code/A型	12ZS31-PG7	12ZS31-PG9
4pins/4针	A code/A型	12ZS33-PG7	12ZS33-PG9
5pins/5针	A code/A型	12ZS35-PG7	12ZS35-PG9
8pins/8针	A code/A型	12ZS37-PG7	12ZS37-PG9
12pins/12针	A code/A型	12ZS73-PG7	12ZS73-PG9
17pins/17针	A code/A型	12ZS71-PG9	

Pin assignment front view/针位分布前视图

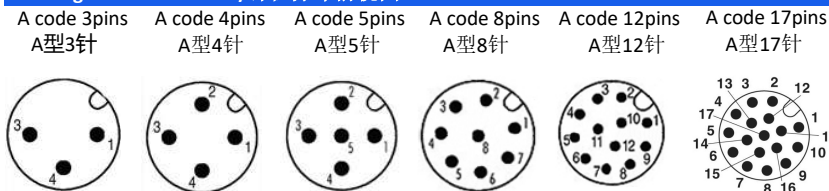

General data/常规数据

Pin Numbers/针数	3pins/3针	4pins/4针	5pins/5针	8pins/8针	12pins/12针	17pins/17针
Rated voltage/额定电压	250V		60V	30V		
Rated current(40°C)/额定电流	4A			2A	1.5A	1.5A
Standards/标准	IEC 61076-2-101					
Termination/焊接方式	screw clamp/螺锁					
Degree of protection/防护等级	IP67					
Wire gauge(mm²)/线规(平方数)	0.14mm²-0.75mm²					
Wire gauge(AWG)/线号(平方数)	26AWG-18AWG					
PG7 hole suitable cable outer diameter/PG7孔适合线材外径	4.0mm-6.0mm					
PG9 hole suitable cable outer diameter/PG9孔适合线材外径	6.0mm-8.0mm					
Mechanical operation/插拔次数	>100 mating cycles/大于100次					
Ambient temperature (operation)/操作温度	-25°C~+85°C					
Contact resistance/接触电阻	≤5mΩ					
Insulation resistance/绝缘电阻	≥100MΩ					
Connector body/胶芯	TPU					
Pin/端子	Brass with gold plated/黄铜镀金					
Screw/螺丝	Brass with nickel plated/黄铜镀镍					
Gasket/胶圈	Fluorine ring/氟胶圈					
Customs tariff number/海关编码	8538900000					
Environmental compliance/环境符合标准	RoHs, Reach					

M12 A code female straight metal assembly connector with shielded/M12, A型母头直头金属装配式连接器, 带屏蔽

Scale drawing/尺寸图

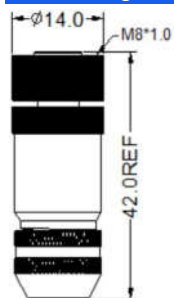

Product photo/产品图



Part number/产品料号

Pins/针数	Code/型	Part number/产品料号	
		PG7 hole/PG7孔	PG9 hole/PG9孔
3pins/3孔	A code/A型	12ZS32-PG7	12ZS32-PG9
4pins/4孔	A code/A型	12ZS34-PG7	12ZS34-PG9
5pins/5孔	A code/A型	12ZS36-PG7	12ZS36-PG9
8pins/8孔	A code/A型	12ZS38-PG7	12ZS38-PG9
12pins/12孔	A code/A型	12ZS74-PG7	12ZS74-PG9
17pins/17孔	A code/A型	12ZS72-PG9	

Pin assignment front view/孔位分布前视图

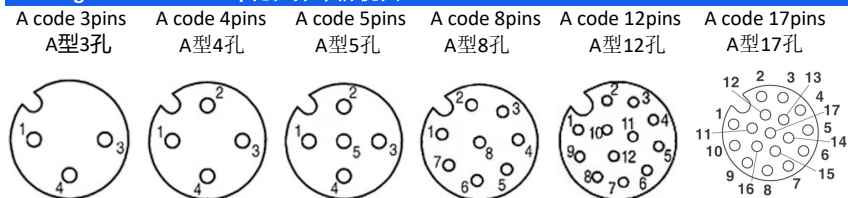

General data/常规数据

Pin Numbers/孔数	3pins/3孔	4pins/4孔	5pins/5孔	8pins/8孔	12pins/12孔	17pins/17孔
Rated voltage/额定电压	250V		60V	30V		
Rated current(40°C)/额定电流	4A			2A	1.5A	1.5A
Standards/标准	IEC 61076-2-101					
Termination/焊接方式	screw clamp/螺锁					
Degree of protection/防护等级	IP67					
Wire gauge(mm²)/线规(平方数)	0.14mm²-0.75mm²					
Wire gauge(AWG)/线号(平方数)	26AWG-18AWG					
PG7 hole suitable cable outer diameter/PG7孔适合线材外径	4.0mm-6.0mm					
PG9 hole suitable cable outer diameter/PG9孔适合线材外径	6.0mm-8.0mm					
Mechanical operation/插拔次数	>100 mating cycles/大于100次					
Ambient temperature (operation)/操作温度	-25°C~+85°C					
Contact resistance/接触电阻	≤5mΩ					
Insulation resistance/绝缘电阻	≥100MΩ					
Connector body/胶芯	TPU					
Pin/端子	Phosphorus copper with gold plated/磷铜镀金					
Screw/螺丝	Brass with nickel plated/黄铜镀镍					
Gasket/胶圈	Fluorine ring/氟胶圈					
Customs tariff number/海关编码	8538900000					
Environmental compliance/环境符合标准	RoHs, Reach					

M12 A code male right angle metal assembly connector with shielded/M12, A型公头弯头金属装配式连接器, 带屏蔽

Scale drawing/尺寸图

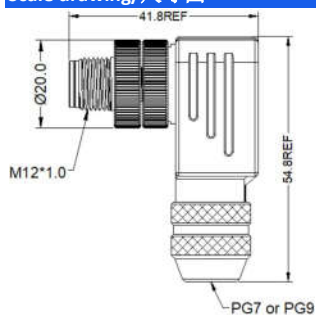

Product photo/产品图



Part number/产品料号

Pins/针数	Code/型	Part number/产品料号	
		PG7 hole/PG7孔	PG9 hole/PG9孔
3pins/3针	A code/A型	12ZS41-PG7	12ZS41-PG9
4pins/4针	A code/A型	12ZS43-PG7	12ZS43-PG9
5pins/5针	A code/A型	12ZS45-PG7	12ZS45-PG9
8pins/8针	A code/A型	12ZS47-PG7	12ZS47-PG9
12pins/12针	A code/A型	12ZS75-PG7	12ZS75-PG9
17pins/17针	A code/A型	12ZS77-PG9	

Pin assignment front view/针位分布前视图

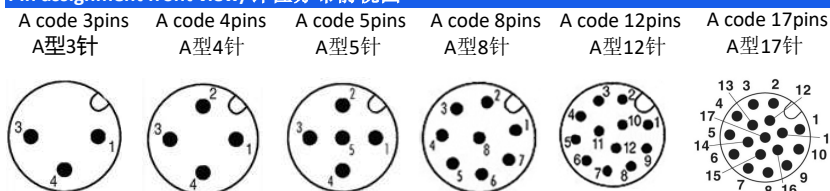

General data/常规数据

Pin Numbers/针数	3pins/3针	4pins/4针	5pins/5针	8pins/8针	12pins/12针	17pins/17针
Rated voltage/额定电压	250V		60V	30V		
Rated current(40°C)/额定电流	4A			2A	1.5A	1.5A
Standards/标准	IEC 61076-2-101					
Termination/焊接方式	screw clamp/螺锁					
Degree of protection/防护等级	IP67					
Wire gauge(mm²)/线规(平方数)	0.14mm²-0.75mm²					
Wire gauge(AWG)/线号(平方数)	26AWG-18AWG					
PG7 hole suitable cable outer diameter/PG7孔适合线材外径	4.0mm-6.0mm					
PG9 hole suitable cable outer diameter/PG9孔适合线材外径	6.0mm-8.0mm					
Mechanical operation/插拔次数	>100 mating cycles/大于100次					
Ambient temperature (operation)/操作温度	-25°C~+85°C					
Contact resistance/接触电阻	≤5mΩ					
Insulation resistance/绝缘电阻	≥100MΩ					
Connector body/胶芯	TPU					
Pin/端子	Brass with gold plated/黄铜镀金					
Screw/螺丝	Brass with nickel plated/黄铜镀镍					
Gasket/胶圈	Fluorine ring/氟胶圈					
Customs tariff number/海关编码	8538900000					
Environmental compliance/环境符合标准	RoHs, Reach					

M12 A code female right angle metal assembly connector with shielded/M12, A型母头弯头金属装配式连接器, 带屏蔽

Scale drawing/尺寸图

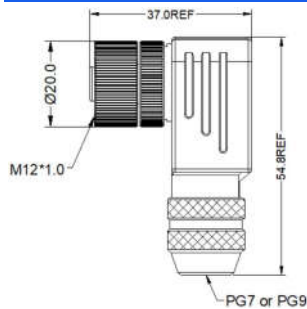

Product photo/产品图



Part number/产品料号

Pins/针数	Code/型	Part number/产品料号	
		PG7 hole/PG7孔	PG9 hole/PG9孔
3pins/3孔	A code/A型	12ZS42-PG7	12ZS42-PG9
4pins/4孔	A code/A型	12ZS44-PG7	12ZS44-PG9
5pins/5孔	A code/A型	12ZS46-PG7	12ZS46-PG9
8pins/8孔	A code/A型	12ZS48-PG7	12ZS48-PG9
12pins/12孔	A code/A型	12ZS76-PG7	12ZS76-PG9
17pins/17孔	A code/A型	12ZS78-PG9	

Pin assignment front view/孔位分布前视图

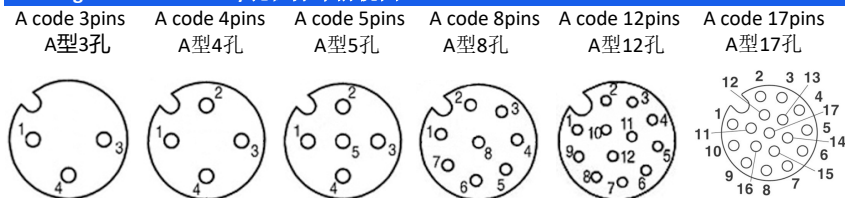

General data/常规数据

Pin Numbers/孔数	3pins/3孔	4pins/4孔	5pins/5孔	8pins/8孔	12pins/12孔	17pins/17孔
Rated voltage/额定电压	250V		60V	30V		
Rated current(40°C)/额定电流	4A			2A	1.5A	1.5A
Standards/标准	IEC 61076-2-101					
Termination/焊接方式	screw clamp/螺锁					
Degree of protection/防护等级	IP67					
Wire gauge(mm²)/线规(平方数)	0.14mm²-0.75mm²					
Wire gauge(AWG)/线号(平方数)	26AWG-18AWG					
PG7 hole suitable cable outer diameter/PG7孔适合线材外径	4.0mm-6.0mm					
PG9 hole suitable cable outer diameter/PG9孔适合线材外径	6.0mm-8.0mm					
Mechanical operation/插拔次数	>100 mating cycles/大于100次					
Ambient temperature (operation)/操作温度	-25°C~+85°C					
Contact resistance/接触电阻	≤5mΩ					
Insulation resistance/绝缘电阻	≥100MΩ					
Connector body/胶芯	TPU					
Pin/端子	Phosphorus copper with gold plated/磷铜镀金					
Screw/螺丝	Brass with nickel plated/黄铜镀镍					
Gasket/胶圈	Fluorine ring/氟胶圈					
Customs tariff number/海关编码	8538900000					
Environmental compliance/环境符合标准	RoHs, Reach					

M12 A code male straight molded cable, unshielded/M12, A型公头直头成型式连接线, 不带屏蔽

Scale drawing/尺寸图

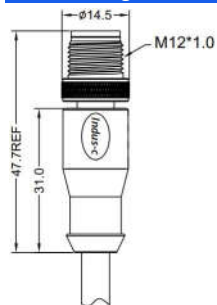

Product photo/产品图



Part number/产品料号

Pins/针数	Code/型	Part number("X" is length millimetre mm)/产品料号("X"表示长度, 单位毫米mm)		
		PVC jacket/PVC外被		PUR jacket/PUR外被
		-10°C~+80°C	-40°C~+105°C	-40°C~+105°C
3pins/3针	A code/A型	12L00123-X	12L00199-X	12L00200-X
4pins/4针	A code/A型	12L00124-X	12L00210-X	12L00183-X
5pins/5针	A code/A型	12L00125-X	12L00236-X	12L00237-X
8pins/8针	A code/A型	12L00191-X	12L00251-X	12L00007-X
12pins/12针	A code/A型	12L00266-X	12L00267-X	12L00268-X
17pins/17针	A code/A型	12L00293-X	12L00294-X	12L00295-X

Pin assignment front view/针位分布前视图

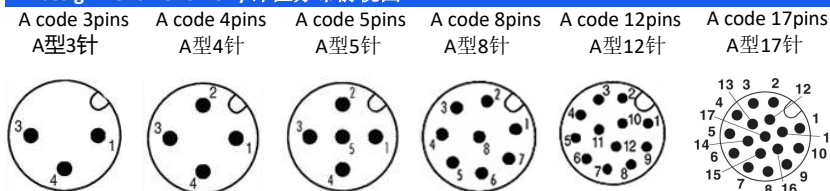

General data/常规数据

Pin Numbers/针数	3pins/3针	4pins/4针	5pins/5针	8pins/8针	12pins/12针	17pins/17针
Rated voltage/额定电压	250V		60V	30V		
Rated current(40°C)/额定电流	4A		2A			
Standards/标准	IEC 61076-2-101					
Termination/焊接方式	Solder and over-mold/焊接和成型					
Connector locking system/锁紧方式	Screw/螺锁					
Degree of protection/防护等级	IP67, IP68, IP69K					
Wire gauge(mm²)/线规(平方数)	0.14mm²-0.75mm²					
Wire gauge(AWG)/线号(平方数)	26AWG-18AWG					
Mechanical operation/插拔次数	>100 mating cycles/大于100次					
Contact resistance/接触电阻	≤5mΩ					
Insulation resistance/绝缘电阻	≥100MΩ					
Connector body/胶芯	TPU					
Pin/端子	Brass with gold plated/黄铜镀金					
Screw/螺丝	Brass with nickel plated/黄铜镀镍					
Over-mold/成型	TPU					
Customs tariff number/海关编码	8518900001					
Environmental compliance/环境符合标准	RoHs, Reach					

M12 A code female straight molded cable, unshielded/M12, A型母头直头成型式连接线, 不带屏蔽

Scale drawing/尺寸图

Product photo/产品图

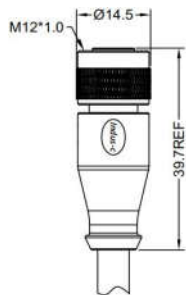

Part number/产品料号

Pins/针数	Code/型	Part number("X" is length millimetre mm)/产品料号("X"表示长度, 单位毫米mm)		
		PVC jacket/PVC外被		PUR jacket/PUR外被
		-10°C~+80°C	-40°C~+105°C	-40°C~+105°C
3pins/3孔	A code/A型	12L00201-X	12L00202-X	12L00203-X
4pins/4孔	A code/A型	12L00169-X	12L00225-X	12L00016-X
5pins/5孔	A code/A型	12L00240-X	12L00116-X	12L00185-X
8pins/8孔	A code/A型	12L00192-X	12L00253-X	12L00254-X
12pins/12孔	A code/A型	12L00197-X	12L00269-X	12L00270-X
17pins/17孔	A code/A型	12L00296-X	12L00297-X	12L00298-X

Pin assignment front view/孔位分布前视图

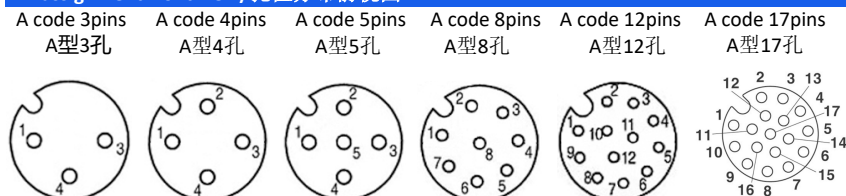

General data/常规数据

Pin Numbers/孔数	3pins/3孔	4pins/4孔	5pins/5孔	8pins/8孔	12pins/12孔	17pins/17孔
Rated voltage/额定电压	250V		60V	30V		
Rated current(40°C)/额定电流	4A		2A		1.5A	1.5A
Standards/标准	IEC 61076-2-101					
Termination/焊接方式	Solder and over-mold/焊接和成型					
Degree of protection/防护等级	IP67, IP68, IP69K					
Wire gauge(mm²)/线规(平方数)	0.14mm²-0.75mm²					
Wire gauge(AWG)/线号(平方数)	26AWG-18AWG					
Mechanical operation/插拔次数	>100 mating cycles/大于100次					
Contact resistance/接触电阻	≤5mΩ					
Insulation resistance/绝缘电阻	≥100MΩ					
Connector body/胶芯	TPU					
Pin/端子	Phosphorus copper with gold plated/磷铜镀金					
Screw/螺丝	Brass with nickel plated/黄铜镀镍					
Over-mold/成型	TPU					
Gasket/胶圈	Fluorine ring/氟胶圈					
Customs tariff number/海关编码	8518900001					
Environmental compliance/环境符合标准	RoHs, Reach					

M12 A code male right angle molded cable, unshielded/M12, A型公头弯头成型式连接线, 不带屏蔽

Scale drawing/尺寸图

Product photo/产品图

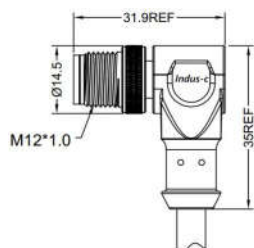

Part number/产品料号

Pins/针数	Code/型	Part number("X" is length millimetre mm)/产品料号("X"表示长度, 单位毫米mm)		
		PVC jacket/PVC外被	PUR jacket/PUR外被	
		-10°C~+80°C	-40°C~+105°C	-40°C~+105°C
3pins/3针	A code/A型	12L00204-X	12L00205-X	12L00206-X
4pins/4针	A code/A型	12L00222-X	12L00223-X	12L00224-X
5pins/5针	A code/A型	12L00181-X	12L00238-X	12L00239-X
8pins/8针	A code/A型	12L00163-X	12L00252-X	12L00006-X
12pins/12针	A code/A型	12L00271-X	12L00272-X	12L00273-X
17pins/17针	A code/A型	12L00177-X	12L00288-X	12L00289-X

Pin assignment front view/针位分布前视图

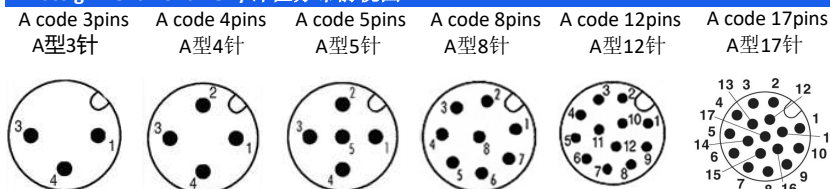

General data/常规数据

Pin Numbers/针数	3pins/3针	4pins/4针	5pins/5针	8pins/8针	12pins/12针	17pins/17针
Rated voltage/额定电压	250V		60V	30V		
Rated current(40°C)/额定电流	4A		2A		1.5A	1.5A
Standards/标准	IEC 61076-2-101					
Termination/焊接方式	Solder and over-mold/焊接和成型					
Degree of protection/防护等级	IP67, IP68, IP69K					
Wire gauge(mm²)/线规(平方数)	0.14mm²-0.75mm²					
Wire gauge(AWG)/线号(平方数)	26AWG-18AWG					
Mechanical operation/插拔次数	>100 mating cycles/大于100次					
Contact resistance/接触电阻	≤5mΩ					
Insulation resistance/绝缘电阻	≥100MΩ					
Connector body/胶芯	TPU					
Pin/端子	Brass with gold plated/黄铜镀金					
Screw/螺丝	Brass with nickel plated/黄铜镀镍					
Over-mold/成型	TPU					
Customs tariff number/海关编码	8518900001					
Environmental compliance/环境符合标准	RoHs, Reach					

M12 A code female right angle molded cable, unshielded/M12, A型母头弯头成型式连接线, 不带屏蔽

Scale drawing/尺寸图

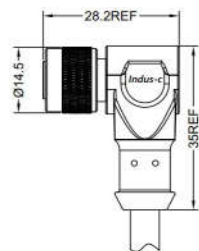

Product photo/产品图



Part number/产品料号

Pins/针数	Code/型	Part number("X" is length millimetre mm)/产品料号("X"表示长度, 单位毫米mm)		
		PVC jacket/PVC外被	PUR jacket/PUR外被	
		-10°C~+80°C	-40°C~+105°C	-40°C~+105°C
3pins/3孔	A code/A型	12L00207-X	12L00208-X	12L00209-X
4pins/4孔	A code/A型	12L00170-X	12L00226-X	12L00029-X
5pins/5孔	A code/A型	12L00241-X	12L00171-X	12L00242-X
8pins/8孔	A code/A型	12L00164-X	12L00255-X	12L00256-X
12pins/12孔	A code/A型	12L00274-X	12L00275-X	12L00276-X
17pins/17孔	A code/A型	12L00290-X	12L00291-X	12L00292-X

Pin assignment front view/孔位分布前视图

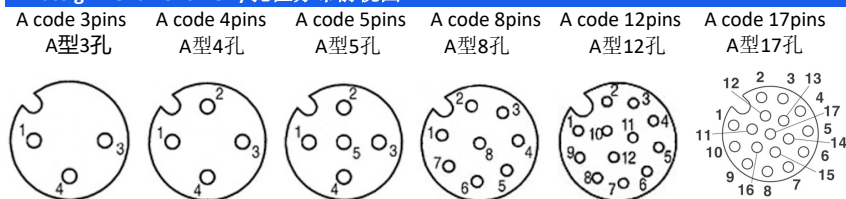

General data/常规数据

Pin Numbers/孔数	3pins/3孔	4pins/4孔	5pins/5孔	8pins/8孔	12pins/12孔	17pins/17孔
Rated voltage/额定电压	250V		60V	30V		
Rated current(40°C)/额定电流	4A		2A			
Standards/标准	IEC 61076-2-101					
Termination/焊接方式	Solder and over-mold/焊接和成型					
Degree of protection/防护等级	IP67, IP68, IP69K					
Wire gauge(mm²)/线规(平方数)	0.14mm²-0.75mm²					
Wire gauge(AWG)/线号(平方数)	26AWG-18AWG					
Mechanical operation/插拔次数	>100 mating cycles/大于100次					
Contact resistance/接触电阻	≤5mΩ					
Insulation resistance/绝缘电阻	≥100MΩ					
Connector body/胶芯	TPU					
Pin/端子	Phosphorus copper with gold plated/磷铜镀金					
Screw/螺丝	Brass with nickel plated/黄铜镀镍					
Over-mold/成型	TPU					
Gasket/胶圈	Fluorine ring/氟胶圈					
Customs tariff number/海关编码	8518900001					
Environmental compliance/环境符合标准	RoHs, Reach					

M12 A code male to male right angle molded cable, unshielded/M12, A型公头弯头对公头弯头连接线, 不带屏蔽

Scale drawing/尺寸图

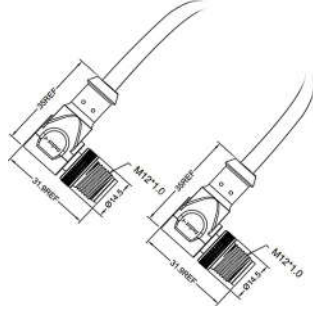

Product photo/产品图



Part number/产品料号

Pins/针数	Code/型	Part number("X" is length millimetre mm)/产品料号("X"表示长度, 单位毫米mm)		
		PVC jacket/PVC外被	PUR jacket/PUR外被	
		-10°C~+80°C	-40°C~+105°C	-40°C~+105°C
3pins/3针	A code/A型	12L00541-X	12L00542-X	12L00543-X
4pins/4针	A code/A型	12L00595-X	12L00596-X	12L00597-X
5pins/5针	A code/A型	12L00653-X	12L00654-X	12L00655-X
8pins/8针	A code/A型	12L00705-X	12L00706-X	12L00707-X
12pins/12针	A code/A型	12L00742-X	12L00743-X	12L00753-X
17pins/17针	A code/A型	12L00825-X	12L00826-X	12L00827-X

Pin assignment front view/针位分布前视图

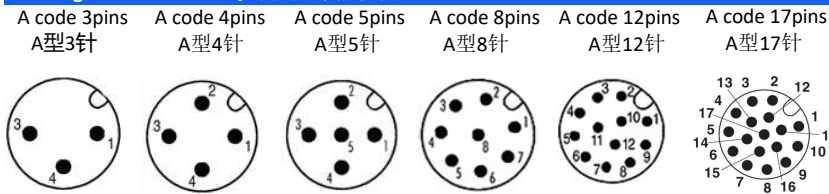

General data/常规数据

Pin Numbers/针数	3pins/3针	4pins/4针	5pins/5针	8pins/8针	12pins/12针	17pins/17针
Rated voltage/额定电压	250V		60V	30V		
Rated current(40°C)/额定电流	4A		2A			
Standards/标准	IEC 61076-2-101					
Termination/焊接方式	Solder and over-mold/焊接和成型					
Degree of protection/防护等级	IP67, IP68, IP69K					
Wire gauge(mm²)/线规(平方数)	0.14mm²-0.75mm²					
Wire gauge(AWG)/线号(平方数)	26AWG-18AWG					
Mechanical operation/插拔次数	>100 mating cycles/大于100次					
Contact resistance/接触电阻	≤5mΩ					
Insulation resistance/绝缘电阻	≥100MΩ					
Connector body/胶芯	TPU					
Pin/端子	Brass with gold plated/黄铜镀金					
Screw/螺丝	Brass with nickel plated/黄铜镀镍					
Over-mold/成型	TPU					
Shielded shell/屏蔽罩	Brass with nickel plated/黄铜镀镍					
Customs tariff number/海关编码	8518900001					
Environmental compliance/环境符合标准	RoHs, Reach					

M12 A code male to female right angle molded cable, unshielded/M12, A型公头弯头对母头弯头连接线, 不带屏蔽

Scale drawing/尺寸图

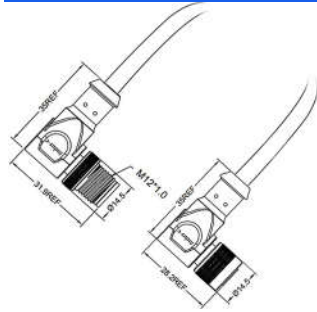

Product photo/产品图



Part number/产品料号

Pins/针数	Code/型	Part number("X" is length millimetre mm)/产品料号("X"表示长度, 单位毫米mm)		
		PVC jacket/PVC外被		PUR jacket/PUR外被
		-10°C~+80°C	-40°C~+105°C	-40°C~+105°C
3pins/3针	A code/A型	12L00641-X	12L00642-X	12L00643-X
4pins/4针	A code/A型	12L00415-X	12L00632-X	12L00634-X
5pins/5针	A code/A型	12L00418-X	12L00656-X	12L00657-X
8pins/8针	A code/A型	12L00408-X	12L00410-X	12L00412-X
12pins/12针	A code/A型	12L00419-X	12L00754-X	12L00755-X
17pins/17针	A code/A型	12L00828-X	12L00829-X	12L00830-X

Pin assignment front view/针位分布前视图

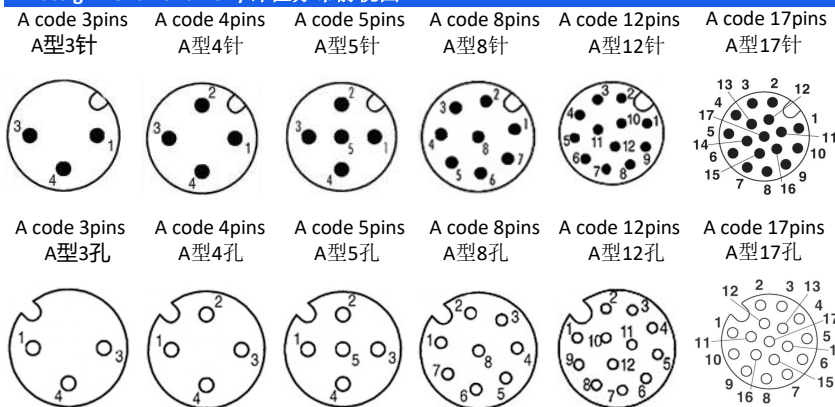

General data/常规数据

Pin Numbers/针数	3pins/3针	4pins/4针	5pins/5针	8pins/8针	12pins/12针	17pins/17针
Rated voltage/额定电压	250V		60V	30V		
Rated current(40°C)/额定电流	4A		2A			
Standards/标准	IEC 61076-2-101					
Termination/焊接方式	Solder and over-mold/焊接和成型					
Degree of protection/防护等级	IP67, IP68, IP69K					
Wire gauge(mm²)/线规(平方数)	0.14mm²-0.75mm²					
Wire gauge(AWG)/线号(平方数)	26AWG-18AWG					
Mechanical operation/插拔次数	>100 mating cycles/大于100次					
Contact resistance/接触电阻	≤5mΩ					
Insulation resistance/绝缘电阻	≥100MΩ					
Connector body/胶芯	TPU					
Male pin/公端子	Brass with gold plated/黄铜镀金					
Female pin/母端子	Phosphorus copper with gold plated/磷铜镀金					
Screw/螺丝	Brass with nickel plated/黄铜镀镍					
Over-mold/成型	TPU					
Shielded shell/屏蔽罩	Brass with nickel plated/黄铜镀镍					
Customs tariff number/海关编码	8518900001					
Environmental compliance/环境符合标准	RoHS, Reach					

M12 A code male right angle to female straight molded cable, unshielded/M12, A型公头弯头对母头直头成型式连接线, 不带屏蔽

Scale drawing/尺寸图

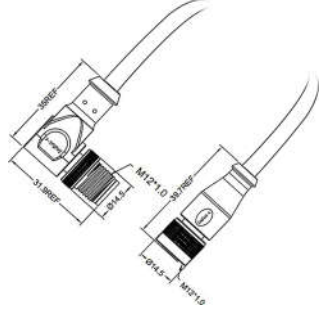

Product photo/产品图



Part number/产品料号

Pins/针数	Code/型	Part number("X" is length millimetre mm)/产品料号("X"表示长度, 单位毫米mm)		
		PVC jacket/PVC外被		PUR jacket/PUR外被
		-10°C~+80°C	-40°C~+105°C	-40°C~+105°C
3pins/3针	A code/A型	12L00644-X	12L00645-X	12L00646-X
4pins/4针	A code/A型	12L00416-X	12L00633-X	12L00635-X
5pins/5针	A code/A型	12L00658-X	12L00659-X	12L00403-X
8pins/8针	A code/A型	12L00708-X	12L00469-X	12L00709-X
12pins/12针	A code/A型	12L00756-X	12L00757-X	12L00758-X
17pins/17针	A code/A型	12L00831-X	12L00832-X	12L00833-X

Pin assignment front view/针位分布前视图

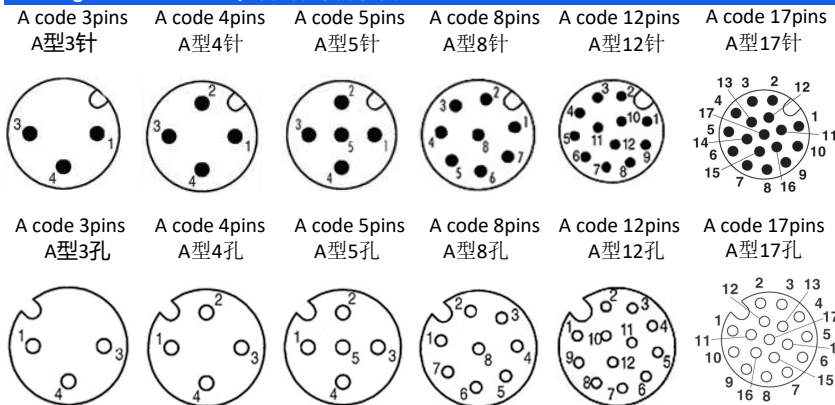

General data/常规数据

Pin Numbers/针数	3pins/3针	4pins/4针	5pins/5针	8pins/8针	12pins/12针	17pins/17针
Rated voltage/额定电压	250V		60V	30V		
Rated current(40°C)/额定电流	4A		2A			
Standards/标准	IEC 61076-2-101					
Termination/焊接方式	Solder and over-mold/焊接和成型					
Degree of protection/防护等级	IP67, IP68, IP69K					
Wire gauge(mm²)/线规(平方数)	0.14mm²-0.75mm²					
Wire gauge(AWG)/线号(平方数)	26AWG-18AWG					
Mechanical operation/插拔次数	>100 mating cycles/大于100次					
Contact resistance/接触电阻	≤5mΩ					
Insulation resistance/绝缘电阻	≥100MΩ					
Connector body/胶芯	TPU					
Male pin/公端子	Brass with gold plated/黄铜镀金					
Female pin/母端子	Phosphorus copper with gold plated/磷铜镀金					
Screw/螺丝	Brass with nickel plated/黄铜镀镍					
Over-mold/成型	TPU					
Shielded shell/屏蔽罩	Brass with nickel plated/黄铜镀镍					
Customs tariff number/海关编码	8518900001					
Environmental compliance/环境符合标准	RoHS, Reach					

M12 A code male straight to male right angle molded cable, unshielded/M12, A型公头直头对公头弯头连接线, 不带屏蔽

Scale drawing/尺寸图

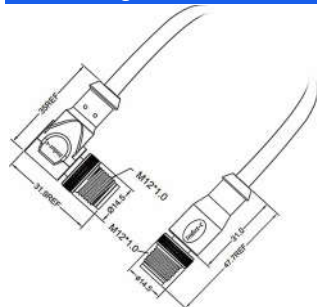

Product photo/产品图



Part number/产品料号

Pins/针数	Code/型	Part number("X" is length millimetre mm)/产品料号("X"表示长度, 单位毫米mm)		
		PVC jacket/PVC外被		PUR jacket/PUR外被
		-10°C~+80°C	-40°C~+105°C	-40°C~+105°C
3pins/3针	A code/A型	12L00544-X	12L00545-X	12L00546-X
4pins/4针	A code/A型	12L00598-X	12L00599-X	12L00600-X
5pins/5针	A code/A型	12L00660-X	12L00661-X	12L00662-X
8pins/8针	A code/A型	12L00710-X	12L00711-X	12L00712-X
12pins/12针	A code/A型	12L00759-X	12L00760-X	12L00761-X
17pins/17针	A code/A型	12L00834-X	12L00834-X	12L00834-X

Pin assignment front view/针位分布前视图

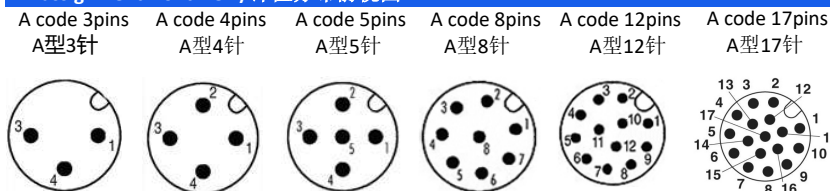

General data/常规数据

Pin Numbers/针数	3pins/3针	4pins/4针	5pins/5针	8pins/8针	12pins/12针	17pins/17针
Rated voltage/额定电压	250V		60V	30V		
Rated current(40°C)/额定电流	4A		2A		1.5A	1.5A
Standards/标准	IEC 61076-2-101					
Termination/焊接方式	Solder and over-mold/焊接和成型					
Degree of protection/防护等级	IP67, IP68, IP69K					
Wire gauge(mm²)/线规(平方数)	0.14mm²-0.75mm²					
Wire gauge(AWG)/线号(平方数)	26AWG-18AWG					
Mechanical operation/插拔次数	>100 mating cycles/大于100次					
Contact resistance/接触电阻	≤5mΩ					
Insulation resistance/绝缘电阻	≥100MΩ					
Connector body/胶芯	TPU					
Male pin/公端子	Brass with gold plated/黄铜镀金					
Female pin/母端子	Phosphorus copper with gold plated/磷铜镀金					
Screw/螺丝	Brass with nickel plated/黄铜镀镍					
Over-mold/成型	TPU					
Shielded shell/屏蔽罩	Brass with nickel plated/黄铜镀镍					
Customs tariff number/海关编码	8518900001					
Environmental compliance/环境符合标准	RoHs, Reach					

M12 A code male to male straight molded cable, unshielded/M12, A型公头直头对公头直头连接线, 不带屏蔽

Scale drawing/尺寸图

Product photo/产品图

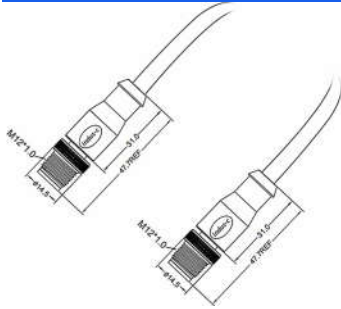

Part number/产品料号

Pins/针数	Code/型	Part number("X" is length millimetre mm)/产品料号("X"表示长度, 单位毫米mm)		
		PVC jacket/PVC外被		PUR jacket/PUR外被
		-10°C~+80°C	-40°C~+105°C	-40°C~+105°C
3pins/3针	A code/A型	12L00547-X	12L00548-X	12L00549-X
4pins/4针	A code/A型	12L00377-X	12L00593-X	12L00594-X
5pins/5针	A code/A型	12L00663-X	12L00664-X	12L00665-X
8pins/8针	A code/A型	12L00713-X	12L00714-X	12L00374-X
12pins/12针	A code/A型	12L00762-X	12L00763-X	12L00764-X
17pins/17针	A code/A型	12L00837-X	12L00838-X	12L00839-X

Pin assignment front view/针位分布前视图

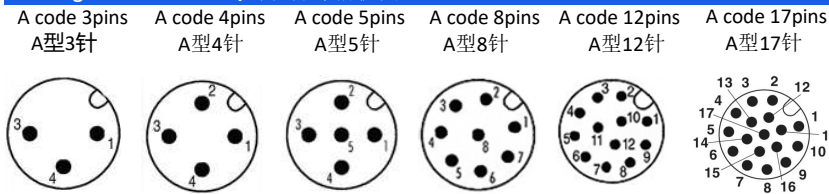

General data/常规数据

Pin Numbers/针数	3pins/3针	4pins/4针	5pins/5针	8pins/8针	12pins/12针	17pins/17针
Rated voltage/额定电压	250V		60V	30V		
Rated current(40°C)/额定电流	4A		2A		1.5A	1.5A
Standards/标准	IEC 61076-2-101					
Termination/焊接方式	Solder and over-mold/焊接和成型					
Degree of protection/防护等级	IP67, IP68, IP69K					
Wire gauge(mm²)/线规(平方数)	0.14mm²-0.75mm²					
Wire gauge(AWG)/线号(平方数)	26AWG-18AWG					
Mechanical operation/插拔次数	>100 mating cycles/大于100次					
Contact resistance/接触电阻	≤5mΩ					
Insulation resistance/绝缘电阻	≥100MΩ					
Connector body/胶芯	TPU					
Pin/端子	Brass with gold plated/黄铜镀金					
Screw/螺丝	Brass with nickel plated/黄铜镀镍					
Over-mold/成型	TPU					
Shielded shell/屏蔽罩	Brass with nickel plated/黄铜镀镍					
Customs tariff number/海关编码	8518900001					
Environmental compliance/环境符合标准	RoHs, Reach					

M12 A code male straight to female right angle molded cable, unshielded/M12, A型公头直头对母头弯头连接线, 不带屏蔽

Scale drawing/尺寸图

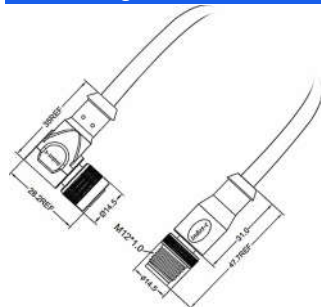

Product photo/产品图



Part number/产品料号

Pins/针数	Code/型	Part number("X" is length millimetre mm)/产品料号("X"表示长度, 单位毫米mm)		
		PVC jacket/PVC外被		PUR jacket/PUR外被
		-10°C~+80°C	-40°C~+105°C	-40°C~+105°C
3pins/3针	A code/A型	12L00550-X	12L00551-X	12L00552-X
4pins/4针	A code/A型	12L00407-X	12L00601-X	12L00602-X
5pins/5针	A code/A型	12L00666-X	12L00667-X	12L00668-X
8pins/8针	A code/A型	12L00715-X	12L00716-X	12L00717-X
12pins/12针	A code/A型	12L00765-X	12L00766-X	12L00767-X
17pins/17针	A code/A型	12L00840-X	12L00841-X	12L00842-X

Pin assignment front view/针位分布前视图

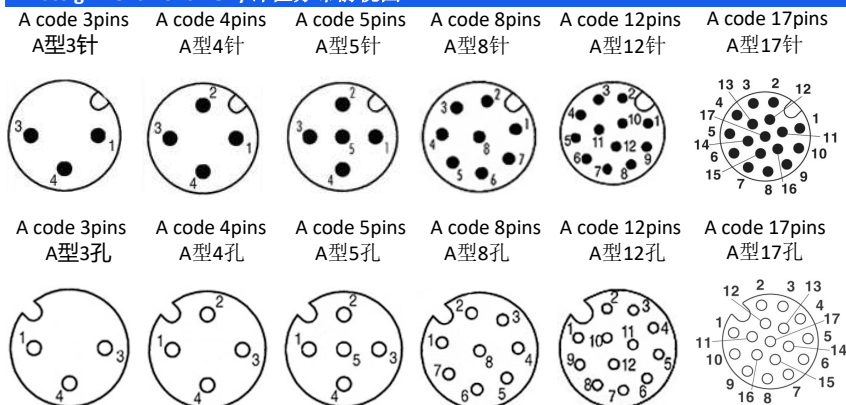

General data/常规数据

Pin Numbers/针数	3pins/3针	4pins/4针	5pins/5针	8pins/8针	12pins/12针	17pins/17针
Rated voltage/额定电压	250V		60V	30V		
Rated current(40°C)/额定电流	4A		2A			
Standards/标准	IEC 61076-2-101					
Termination/焊接方式	Solder and over-mold/焊接和成型					
Degree of protection/防护等级	IP67, IP68, IP69K					
Wire gauge(mm²)/线规(平方数)	0.14mm²-0.75mm²					
Wire gauge(AWG)/线号(平方数)	26AWG-18AWG					
Mechanical operation/插拔次数	>100 mating cycles/大于100次					
Contact resistance/接触电阻	≤5mΩ					
Insulation resistance/绝缘电阻	≥100MΩ					
Connector body/胶芯	TPU					
Male pin/公端子	Brass with gold plated/黄铜镀金					
Female pin/母端子	Phosphorus copper with gold plated/磷铜镀金					
Screw/螺丝	Brass with nickel plated/黄铜镀镍					
Over-mold/成型	TPU					
Shielded shell/屏蔽罩	Brass with nickel plated/黄铜镀镍					
Customs tariff number/海关编码	8518900001					
Environmental compliance/环境符合标准	RoHS, Reach					

M12 A code male to female straight molded cable, unshielded/M12, A型公头直头对母头直头连接线, 不带屏蔽

Scale drawing/尺寸图

Product photo/产品图

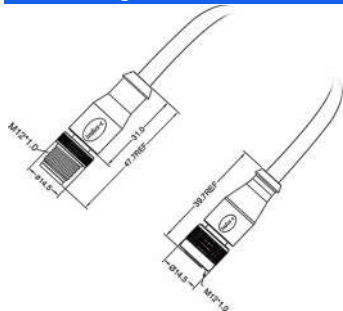

Part number/产品料号

Pins/针数	Code/型	Part number("X" is length millimetre mm)/产品料号("X"表示长度, 单位毫米mm)		
		PVC jacket/PVC外被		PUR jacket/PUR外被
		-10°C~+80°C	-40°C~+105°C	-40°C~+105°C
3pins/3针	A code/A型	12L00173-X	12L00540-X	12L00161-X
4pins/4针	A code/A型	12L00032-X	12L00114-X	12L00405-X
5pins/5针	A code/A型	12L00026-X	12L00160-X	12L00372-X
8pins/8针	A code/A型	12L00193-X	12L00196-X	12L00422-X
12pins/12针	A code/A型	12L00417-X	12L00768-X	12L00769-X
17pins/17针	A code/A型	12L00843-X	12L00844-X	12L00845-X

Pin assignment front view/针位分布前视图

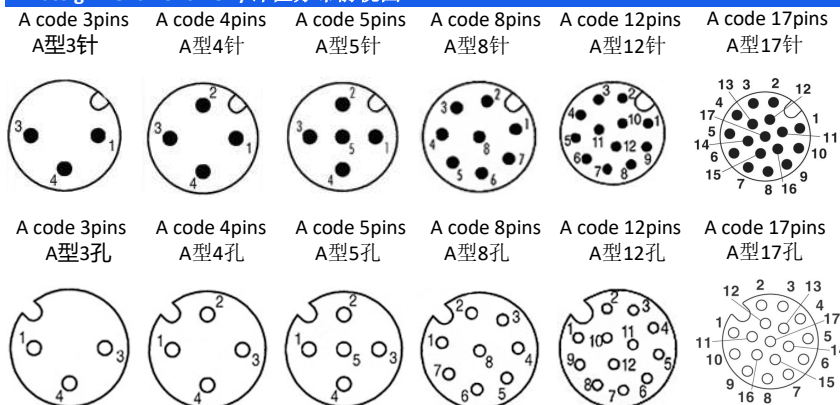

General data/常规数据

Pin Numbers/针数	3pins/3针	4pins/4针	5pins/5针	8pins/8针	12pins/12针	17pins/17针
Rated voltage/额定电压	250V		60V			
Rated current(40°C)/额定电流	4A			2A	1.5A	1.5A
Standards/标准	IEC 61076-2-101					
Termination/焊接方式	Solder and over-mold/焊接和成型					
Degree of protection/防护等级	IP67, IP68, IP69K					
Wire gauge(mm²)/线规(平方数)	0.14mm²-0.75mm²					
Wire gauge(AWG)/线号(平方数)	26AWG-18AWG					
Mechanical operation/插拔次数	>100 mating cycles/大于100次					
Contact resistance/接触电阻	≤5mΩ					
Insulation resistance/绝缘电阻	≥100MΩ					
Connector body/胶芯	TPU					
Male pin/公端子	Brass with gold plated/黄铜镀金					
Female pin/母端子	Phosphorus copper with gold plated/磷铜镀金					
Screw/螺丝	Brass with nickel plated/黄铜镀镍					
Over-mold/成型	TPU					
Shielded shell/屏蔽罩	Brass with nickel plated/黄铜镀镍					
Customs tariff number/海关编码	8518900001					
Environmental compliance/环境符合标准	RoHS, Reach					

M12 A code female to female right angle molded cable, unshielded/M12, A型母头弯头对母头弯头连接线, 不带屏蔽

Scale drawing/尺寸图

Product photo/产品图

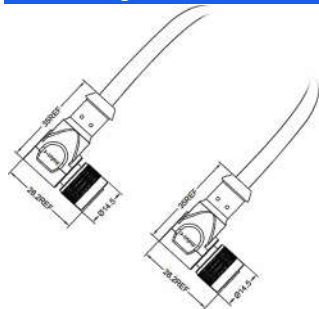

Part number/产品料号

Pins/针数	Code/型	Part number("X" is length millimetre mm)/产品料号("X"表示长度, 单位毫米mm)		
		PVC jacket/PVC外被	PUR jacket/PUR外被	
		-10°C~+80°C	-40°C~+105°C	-40°C~+105°C
3pins/3针	A code/A型	12L00553-X	12L00554-X	12L00555-X
4pins/4针	A code/A型	12L00603-X	12L00604-X	12L00605-X
5pins/5针	A code/A型	12L00669-X	12L00670-X	12L00671-X
8pins/8针	A code/A型	12L00718-X	12L00719-X	12L00720-X
12pins/12针	A code/A型	12L00770-X	12L00771-X	12L00772-X
17pins/17针	A code/A型	12L00846-X	12L00847-X	12L00848-X

Pin assignment front view/针位分布前视图

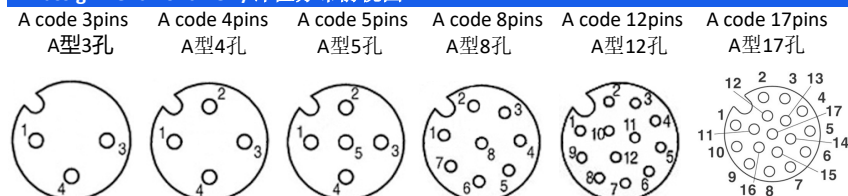

General data/常规数据

Pin Numbers/针数	3pins/3针	4pins/4针	5pins/5针	8pins/8针	12pins/12针	17pins/17针
Rated voltage/额定电压	250V		60V	30V		
Rated current(40°C)/额定电流	4A		2A			
Standards/标准	IEC 61076-2-101					
Termination/焊接方式	Solder and over-mold/焊接和成型					
Degree of protection/防护等级	IP67, IP68, IP69K					
Wire gauge(mm²)/线规(平方数)	0.14mm²-0.75mm²					
Wire gauge(AWG)/线号(平方数)	26AWG-18AWG					
Mechanical operation/插拔次数	>100 mating cycles/大于100次					
Contact resistance/接触电阻	≤5mΩ					
Insulation resistance/绝缘电阻	≥100MΩ					
Connector body/胶芯	TPU					
Pin/母端子	Phosphorus copper with gold plated/磷铜镀金					
Screw/螺丝	Brass with nickel plated/黄铜镀镍					
Over-mold/成型	TPU					
Shielded shell/屏蔽罩	Brass with nickel plated/黄铜镀镍					
Customs tariff number/海关编码	8518900001					
Environmental compliance/环境符合标准	RoHs, Reach					

M12 A code female straight to female right angle molded cable, unshielded/M12, A型母头直头对母头弯头连接线, 不带屏蔽

Scale drawing/尺寸图

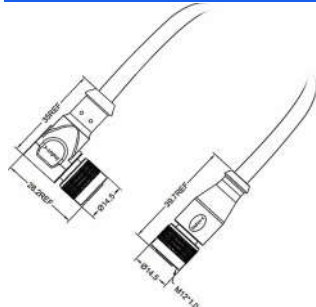

Product photo/产品图



Part number/产品料号

Pins/针数	Code/型	Part number("X" is length millimetre mm)/产品料号("X"表示长度, 单位毫米mm)		
		PVC jacket/PVC外被		PUR jacket/PUR外被
		-10°C~+80°C	-40°C~+105°C	-40°C~+105°C
3pins/3针	A code/A型	12L00556-X	12L00557-X	12L00558-X
4pins/4针	A code/A型	12L00606-X	12L00607-X	12L00608-X
5pins/5针	A code/A型	12L00672-X	12L00673-X	12L00674-X
8pins/8针	A code/A型	12L00721-X	12L00722-X	12L00723-X
12pins/12针	A code/A型	12L00773-X	12L00774-X	12L00775-X
17pins/17针	A code/A型	12L00849-X	12L00850-X	12L00851-X

Pin assignment front view/针位分布前视图

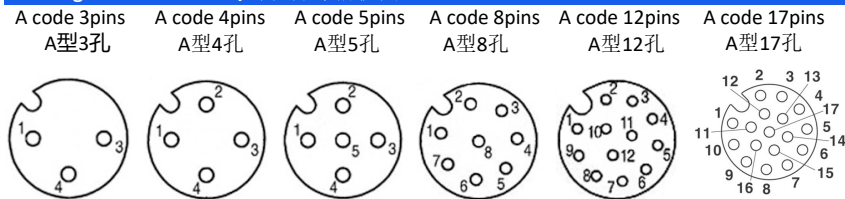

General data/常规数据

Pin Numbers/针数	3pins/3针	4pins/4针	5pins/5针	8pins/8针	12pins/12针	17pins/17针
Rated voltage/额定电压	250V		60V	30V		
Rated current(40°C)/额定电流	4A		2A			
Standards/标准	IEC 61076-2-101					
Termination/焊接方式	Solder and over-mold/焊接和成型					
Degree of protection/防护等级	IP67, IP68, IP69K					
Wire gauge(mm²)/线规(平方数)	0.14mm²-0.75mm²					
Wire gauge(AWG)/线号(平方数)	26AWG-18AWG					
Mechanical operation/插拔次数	>100 mating cycles/大于100次					
Contact resistance/接触电阻	≤5mΩ					
Insulation resistance/绝缘电阻	≥100MΩ					
Connector body/胶芯	TPU					
Pin/母端子	Phosphorus copper with gold plated/磷铜镀金					
Screw/螺丝	Brass with nickel plated/黄铜镀镍					
Over-mold/成型	TPU					
Shielded shell/屏蔽罩	Brass with nickel plated/黄铜镀镍					
Customs tariff number/海关编码	8518900001					
Environmental compliance/环境符合标准	RoHs, Reach					

M12 A code female to female straight molded cable, unshielded/M12, A型母头直头对母头直头连接线, 不带屏蔽

Scale drawing/尺寸图

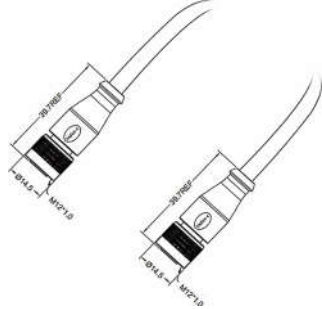

Product photo/产品图



Part number/产品料号

Pins/针数	Code/型	Part number("X" is length millimetre mm)/产品料号("X"表示长度, 单位毫米mm)		
		PVC jacket/PVC外被		PUR jacket/PUR外被
		-10°C~+80°C	-40°C~+105°C	-40°C~+105°C
3pins/3针	A code/A型	12L00559-X	12L00560-X	12L00561-X
4pins/4针	A code/A型	12L00472-X	12L00609-X	12L00610-X
5pins/5针	A code/A型	12L00675-X	12L00115-X	12L00429-X
8pins/8针	A code/A型	12L00508-X	12L00724-X	12L00725-X
12pins/12针	A code/A型	12L00776-X	12L00777-X	12L00778-X
17pins/17针	A code/A型	12L00852-X	12L00853-X	12L00854-X

Pin assignment front view/针位分布前视图

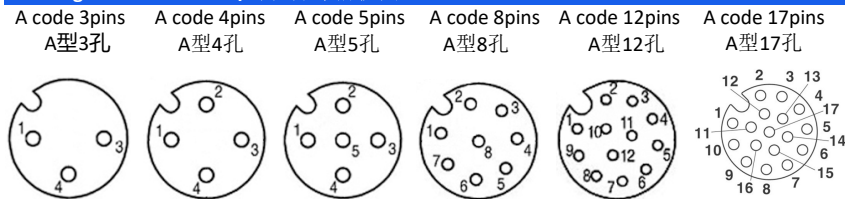

General data/常规数据

Pin Numbers/针数	3pins/3针	4pins/4针	5pins/5针	8pins/8针	12pins/12针	17pins/17针
Rated voltage/额定电压	250V		60V	30V		
Rated current(40°C)/额定电流	4A		2A			1.5A
Standards/标准	IEC 61076-2-101					
Termination/焊接方式	Solder and over-mold/焊接和成型					
Degree of protection/防护等级	IP67, IP68, IP69K					
Wire gauge(mm²)/线规(平方数)	0.14mm²-0.75mm²					
Wire gauge(AWG)/线号(平方数)	26AWG-18AWG					
Mechanical operation/插拔次数	>100 mating cycles/大于100次					
Contact resistance/接触电阻	≤5mΩ					
Insulation resistance/绝缘电阻	≥100MΩ					
Connector body/胶芯	TPU					
Pin/母端子	Phosphorus copper with gold plated/磷铜镀金					
Screw/螺丝	Brass with nickel plated/黄铜镀镍					
Over-mold/成型	TPU					
Shielded shell/屏蔽罩	Brass with nickel plated/黄铜镀镍					
Customs tariff number/海关编码	8518900001					
Environmental compliance/环境符合标准	RoHs, Reach					

M12 A code male straight molded cable, shielded/M12, A型公头直头成型式连接线, 带屏蔽

Scale drawing/尺寸图

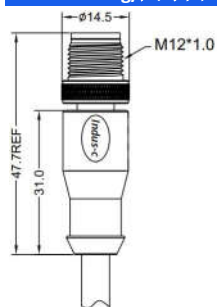

Product photo/产品图



Part number/产品料号

Pins/针数	Code/型	Part number("X" is length millimetre mm)/产品料号("X"表示长度, 单位毫米mm)		
		PVC jacket/PVC外被		PUR jacket/PUR外被
		-10°C~+80°C	-40°C~+105°C	-40°C~+105°C
3pins/3针	A code/A型	12L00210-X	12L00211-X	12L00212-X
4pins/4针	A code/A型	12L00227-X	12L00228-X	12L00120-X
5pins/5针	A code/A型	12L00243-X	12L00244-X	12L00150-X
8pins/8针	A code/A型	12L00260-X	12L00261-X	12L00262-X
12pins/12针	A code/A型	12L00277-X	12L00278-X	12L00279-X
17pins/17针	A code/A型	12L00299-X	12L00300-X	12L00301-X

Pin assignment front view/针位分布前视图

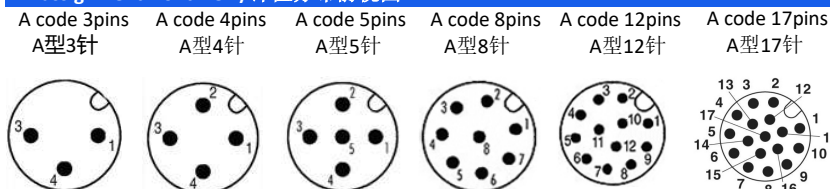

General data/常规数据

Pin Numbers/针数	3pins/3针	4pins/4针	5pins/5针	8pins/8针	12pins/12针	17pins/17针
Rated voltage/额定电压	250V		60V	30V		
Rated current(40°C)/额定电流	4A		2A		1.5A	1.5A
Standards/标准	IEC 61076-2-101					
Termination/焊接方式	Solder and over-mold/焊接和成型					
Degree of protection/防护等级	IP67, IP68, IP69K					
Wire gauge(mm²)/线规(平方数)	0.14mm²-0.75mm²					
Wire gauge(AWG)/线号(平方数)	26AWG-18AWG					
Mechanical operation/插拔次数	>100 mating cycles/大于100次					
Contact resistance/接触电阻	≤5mΩ					
Insulation resistance/绝缘电阻	≥100MΩ					
Connector body/胶芯	TPU					
Pin/端子	Brass with gold plated/黄铜镀金					
Screw/螺丝	Brass with nickel plated/黄铜镀镍					
Over-mold/成型	TPU					
Shielded shell/屏蔽罩	Brass with nickel plated/黄铜镀镍					
Customs tariff number/海关编码	8518900001					
Environmental compliance/环境符合标准	RoHs, Reach					

M12 A code female straight molded cable, shielded/M12, A型母头直头成型式连接线, 带屏蔽

Scale drawing/尺寸图

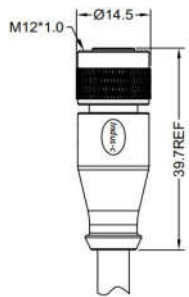

Product photo/产品图



Part number/产品料号

Pins/针数	Code/型	Part number("X" is length millimetre mm)/产品料号("X"表示长度, 单位毫米mm)		
		PVC jacket/PVC外被		PUR jacket/PUR外被
		-10°C~+80°C	-40°C~+105°C	-40°C~+105°C
3pins/3孔	A code/A型	12L00213-X	12L00214-X	12L00215-X
4pins/4孔	A code/A型	12L00233-X	12L00234-X	12L00235-X
5pins/5孔	A code/A型	12L00247-X	12L00248-X	12L00147-X
8pins/8孔	A code/A型	12L00263-X	12L00264-X	12L00017-X
12pins/12孔	A code/A型	12L00198-X	12L00280-X	12L00281-X
17pins/17孔	A code/A型	12L00302-X	12L00303-X	12L00304-X

Pin assignment front view/孔位分布前视图

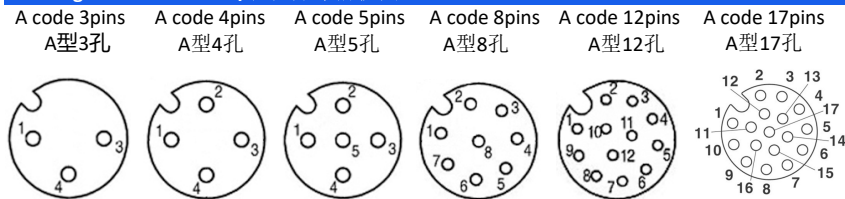

General data/常规数据

Pin Numbers/孔数	3pins/3孔	4pins/4孔	5pins/5孔	8pins/8孔	12pins/12孔	17pins/17孔
Rated voltage/额定电压	250V		60V	30V		
Rated current(40°C)/额定电流	4A		2A		1.5A	1.5A
Standards/标准	IEC 61076-2-101					
Termination/焊接方式	Solder and over-mold/焊接和成型					
Degree of protection/防护等级	IP67, IP68, IP69K					
Wire gauge(mm²)/线规(平方数)	0.14mm²-0.75mm²					
Wire gauge(AWG)/线号(平方数)	26AWG-18AWG					
Mechanical operation/插拔次数	>100 mating cycles/大于100次					
Contact resistance/接触电阻	≤5mΩ					
Insulation resistance/绝缘电阻	≥100MΩ					
Connector body/胶芯	TPU					
Pin/端子	Phosphorus copper with gold plated/磷铜镀金					
Screw/螺丝	Brass with nickel plated/黄铜镀镍					
Over-mold/成型	TPU					
Shielded shell/屏蔽罩	Brass with nickel plated/黄铜镀镍					
Gasket/胶圈	Fluorine ring/氟胶圈					
Customs tariff number/海关编码	8518900001					
Environmental compliance/环境符合标准	RoHs, Reach					

M12 A code male right angle molded cable, shielded/M12, A型公头弯头成型式连接线, 带屏蔽

Scale drawing/尺寸图

Product photo/产品图

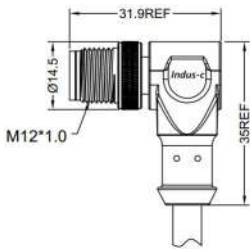

Part number/产品料号

Pins/针数	Code/型	Part number("X" is length millimetre mm)/产品料号("X"表示长度, 单位毫米mm)		
		PVC jacket/PVC外被		PUR jacket/PUR外被
		-10°C~+80°C	-40°C~+105°C	-40°C~+105°C
3pins/3针	A code/A型	12L00216-X	12L00217-X	12L00218-X
4pins/4针	A code/A型	12L00229-X	12L00145-X	12L00230-X
5pins/5针	A code/A型	12L00245-X	12L00246-X	12L00002-X
8pins/8针	A code/A型	12L00257-X	12L00311-X	12L00258-X
12pins/12针	A code/A型	12L00282-X	12L00283-X	12L00284-X
17pins/17针	A code/A型	12L00305-X	12L00306-X	12L00307-X

Pin assignment front view/针位分布前视图

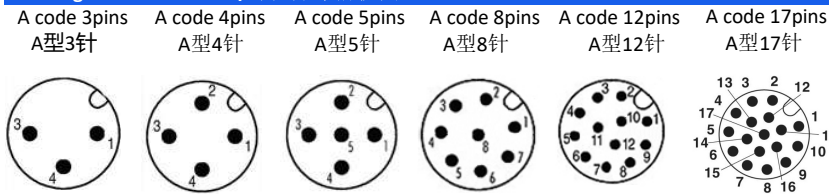

General data/常规数据

Pin Numbers/针数	3pins/3针	4pins/4针	5pins/5针	8pins/8针	12pins/12针	17pins/17针
Rated voltage/额定电压	250V		60V	30V		
Rated current(40°C)/额定电流	4A		2A		1.5A	1.5A
Standards/标准	IEC 61076-2-101					
Termination/焊接方式	Solder and over-mold/焊接和成型					
Degree of protection/防护等级	IP67, IP68, IP69K					
Wire gauge(mm²)/线规(平方数)	0.14mm²-0.75mm²					
Wire gauge(AWG)/线号(平方数)	26AWG-18AWG					
Mechanical operation/插拔次数	>100 mating cycles/大于100次					
Contact resistance/接触电阻	≤5mΩ					
Insulation resistance/绝缘电阻	≥100MΩ					
Connector body/胶芯	TPU					
Pin/端子	Brass with gold plated/黄铜镀金					
Screw/螺丝	Brass with nickel plated/黄铜镀镍					
Over-mold/成型	TPU					
Shielded shell/屏蔽罩	Brass with nickel plated/黄铜镀镍					
Customs tariff number/海关编码	8518900001					
Environmental compliance/环境符合标准	RoHs, Reach					

M12 A code female right angle molded cable, shielded/M12, A型母头弯头成型式连接线, 带屏蔽

Scale drawing/尺寸图

Product photo/产品图

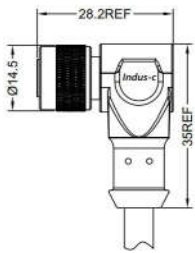

Part number/产品料号

Pins/针数	Code/型	Part number("X" is length millimetre mm)/产品料号("X"表示长度, 单位毫米mm)		
		PVC jacket/PVC外被		PUR jacket/PUR外被
		-10°C~+80°C	-40°C~+105°C	-40°C~+105°C
3pins/3孔	A code/A型	12L00219-X	12L00220-X	12L00221-X
4pins/4孔	A code/A型	12L00231-X	12L00108-X	12L00232-X
5pins/5孔	A code/A型	12L00249-X	12L00250-X	12L00151-X
8pins/8孔	A code/A型	12L00259-X	12L00312-X	12L00265-X
12pins/12孔	A code/A型	12L00285-X	12L00286-X	12L00287-X
17pins/17孔	A code/A型	12L00308-X	12L00309-X	12L00310-X

Pin assignment front view/孔位分布前视图

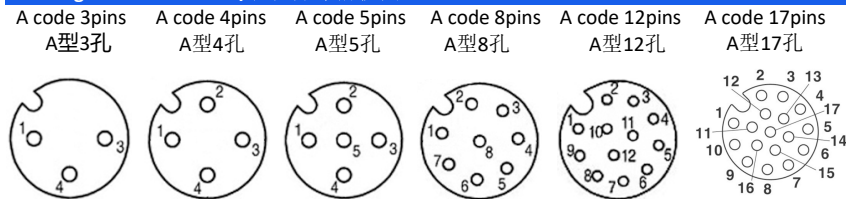

General data/常规数据

Pin Numbers/孔数	3pins/3孔	4pins/4孔	5pins/5孔	8pins/8孔	12pins/12孔	17pins/17孔
Rated voltage/额定电压	250V		60V	30V		
Rated current(40°C)/额定电流	4A		2A		1.5A	1.5A
Standards/标准	IEC 61076-2-101					
Termination/焊接方式	Solder and over-mold/焊接和成型					
Degree of protection/防护等级	IP67, IP68, IP69K					
Wire gauge(mm²)/线规(平方数)	0.14mm²-0.75mm²					
Wire gauge(AWG)/线号(平方数)	26AWG-18AWG					
Mechanical operation/插拔次数	>100 mating cycles/大于100次					
Contact resistance/接触电阻	≤5mΩ					
Insulation resistance/绝缘电阻	≥100MΩ					
Connector body/胶芯	TPU					
Pin/端子	Phosphorus copper with gold plated/磷铜镀金					
Screw/螺丝	Brass with nickel plated/黄铜镀镍					
Over-mold/成型	TPU					
Shielded shell/屏蔽罩	Brass with nickel plated/黄铜镀镍					
Gasket/胶圈	Fluorine ring/氟胶圈					
Customs tariff number/海关编码	8518900001					
Environmental compliance/环境符合标准	RoHs, Reach					

M12 A code male to male right angle molded cable, shielded/M12, A型公头弯头对公头弯头连接线, 带屏蔽

Scale drawing/尺寸图

Product photo/产品图

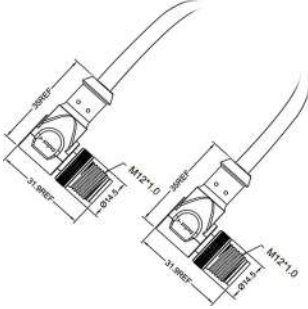

Part number/产品料号

Pins/针数	Code/型	Part number("X" is length millimetre mm)/产品料号("X"表示长度, 单位毫米mm)		
		PVC jacket/PVC外被		PUR jacket/PUR外被
		-10°C~+80°C	-40°C~+105°C	-40°C~+105°C
3pins/3针	A code/A型	12L00565-X	12L00566-X	12L00567-X
4pins/4针	A code/A型	12L00611-X	12L00612-X	12L00613-X
5pins/5针	A code/A型	12L00676-X	12L00677-X	12L00503-X
8pins/8针	A code/A型	12L00726-X	12L00727-X	12L00728-X
12pins/12针	A code/A型	12L00779-X	12L00780-X	12L00426-X
17pins/17针	A code/A型	12L00855-X	12L00856-X	12L00857-X

Pin assignment front view/针位分布前视图

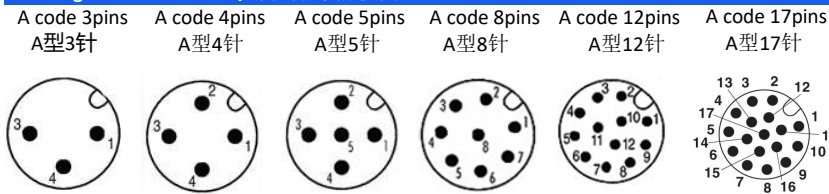

General data/常规数据

Pin Numbers/针数	3pins/3针	4pins/4针	5pins/5针	8pins/8针	12pins/12针	17pins/17针
Rated voltage/额定电压	250V		60V	30V		
Rated current(40°C)/额定电流	4A		2A			
Standards/标准	IEC 61076-2-101					
Termination/焊接方式	Solder and over-mold/焊接和成型					
Degree of protection/防护等级	IP67, IP68, IP69K					
Wire gauge(mm²)/线规(平方数)	0.14mm²-0.75mm²					
Wire gauge(AWG)/线号(平方数)	26AWG-18AWG					
Mechanical operation/插拔次数	>100 mating cycles/大于100次					
Contact resistance/接触电阻	≤5mΩ					
Insulation resistance/绝缘电阻	≥100MΩ					
Connector body/胶芯	TPU					
Pin/端子	Brass with gold plated/黄铜镀金					
Screw/螺丝	Brass with nickel plated/黄铜镀镍					
Over-mold/成型	TPU					
Shielded shell/屏蔽罩	Brass with nickel plated/黄铜镀镍					
Customs tariff number/海关编码	8518900001					
Environmental compliance/环境符合标准	RoHs, Reach					

M12 A code male to female right angle molded cable, shielded/M12, A型公头弯头对母头弯头连接线, 带屏蔽

Scale drawing/尺寸图

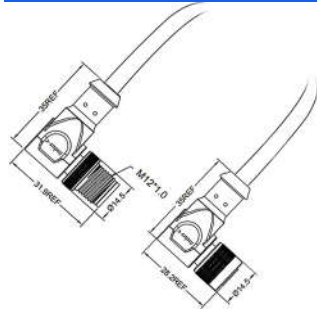

Product photo/产品图



Part number/产品料号

Pins/针数	Code/型	Part number("X" is length millimetre mm)/产品料号("X"表示长度, 单位毫米mm)		
		PVC jacket/PVC外被		PUR jacket/PUR外被
		-10°C~+80°C	-40°C~+105°C	-40°C~+105°C
3pins/3针	A code/A型	12L00647-X	12L00648-X	12L00649-X
4pins/4针	A code/A型	12L00637-X	12L00639-X	12L00636-X
5pins/5针	A code/A型	12L00678-X	12L00679-X	12L00680-X
8pins/8针	A code/A型	12L00409-X	12L00411-X	12L00413-X
12pins/12针	A code/A型	12L00781-X	12L00782-X	12L00783-X
17pins/17针	A code/A型	12L00858-X	12L00859-X	12L00860-X

Pin assignment front view/针位分布前视图

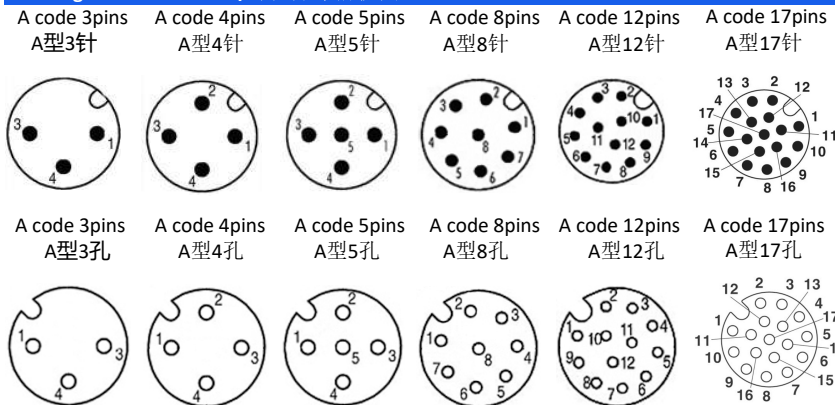

General data/常规数据

Pin Numbers/针数	3pins/3针	4pins/4针	5pins/5针	8pins/8针	12pins/12针	17pins/17针
Rated voltage/额定电压	250V		60V			
Rated current(40°C)/额定电流	4A			2A	1.5A	1.5A
Standards/标准	IEC 61076-2-101					
Termination/焊接方式	Solder and over-mold/焊接和成型					
Degree of protection/防护等级	IP67, IP68, IP69K					
Wire gauge(mm²)/线规(平方数)	0.14mm²-0.75mm²					
Wire gauge(AWG)/线号(平方数)	26AWG-18AWG					
Mechanical operation/插拔次数	>100 mating cycles/大于100次					
Contact resistance/接触电阻	≤5mΩ					
Insulation resistance/绝缘电阻	≥100MΩ					
Connector body/胶芯	TPU					
Male pin/公端子	Brass with gold plated/黄铜镀金					
Female pin/母端子	Phosphorus copper with gold plated/磷铜镀金					
Screw/螺丝	Brass with nickel plated/黄铜镀镍					
Over-mold/成型	TPU					
Shielded shell/屏蔽罩	Brass with nickel plated/黄铜镀镍					
Customs tariff number/海关编码	8518900001					
Environmental compliance/环境符合标准	RoHS, Reach					

M12 A code male right angle to female straight molded cable, shielded/M12, A型公头弯头对母头直头成型式连接线, 带屏蔽

Scale drawing/尺寸图

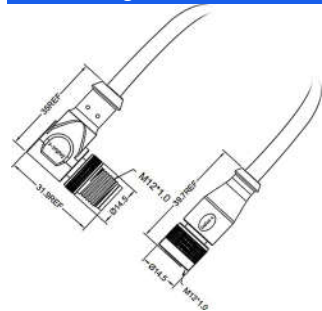

Product photo/产品图



Part number/产品料号

Pins/针数	Code/型	Part number("X" is length millimetre mm)/产品料号("X"表示长度, 单位毫米mm)		
		PVC jacket/PVC外被	PUR jacket/PUR外被	
		-10°C~+80°C	-40°C~+105°C	-40°C~+105°C
3pins/3针	A code/A型	12L00650-X	12L00651-X	12L00652-X
4pins/4针	A code/A型	12L00638-X	12L00640-X	12L00031-X
5pins/5针	A code/A型	12L00681-X	12L00682-X	12L00683-X
8pins/8针	A code/A型	12L00729-X	12L00730-X	12L00731-X
12pins/12针	A code/A型	12L00784-X	12L00785-X	12L00786-X
17pins/17针	A code/A型	12L00861-X	12L00862-X	12L00863-X

Pin assignment front view/针位分布前视图

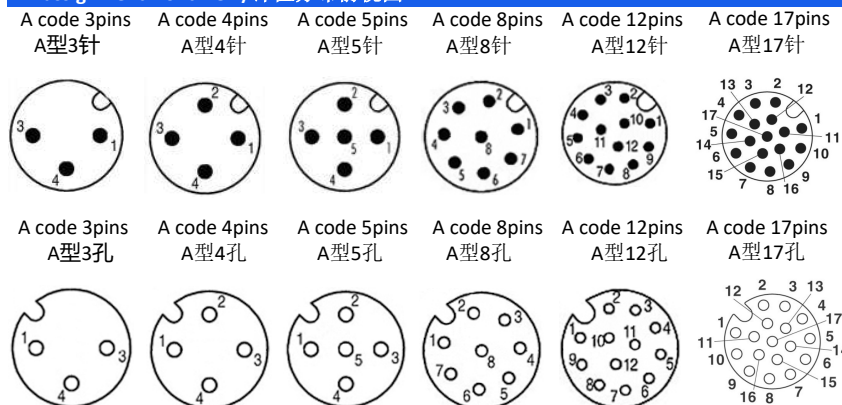

General data/常规数据

Pin Numbers/针数	3pins/3针	4pins/4针	5pins/5针	8pins/8针	12pins/12针	17pins/17针
Rated voltage/额定电压	250V		60V	30V		
Rated current(40°C)/额定电流	4A		2A			
Standards/标准	IEC 61076-2-101					
Termination/焊接方式	Solder and over-mold/焊接和成型					
Degree of protection/防护等级	IP67, IP68, IP69K					
Wire gauge(mm²)/线规(平方数)	0.14mm²-0.75mm²					
Wire gauge(AWG)/线号(平方数)	26AWG-18AWG					
Mechanical operation/插拔次数	>100 mating cycles/大于100次					
Contact resistance/接触电阻	≤5mΩ					
Insulation resistance/绝缘电阻	≥100MΩ					
Connector body/胶芯	TPU					
Male pin/公端子	Brass with gold plated/黄铜镀金					
Female pin/母端子	Phosphorus copper with gold plated/磷铜镀金					
Screw/螺丝	Brass with nickel plated/黄铜镀镍					
Over-mold/成型	TPU					
Shielded shell/屏蔽罩	Brass with nickel plated/黄铜镀镍					
Customs tariff number/海关编码	8518900001					
Environmental compliance/环境符合标准	RoHS, Reach					

M12 A code male straight to male right angle molded cable, shielded/M12, A型公头直头对公头弯头连接线, 带屏蔽

Scale drawing/尺寸图

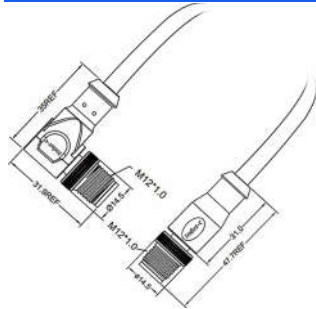

Product photo/产品图



Part number/产品料号

Pins/针数	Code/型	Part number("X" is length millimetre mm)/产品料号("X"表示长度, 单位毫米mm)		
		PVC jacket/PVC外被		PUR jacket/PUR外被
		-10°C~+80°C	-40°C~+105°C	-40°C~+105°C
3pins/3针	A code/A型	12L00568-X	12L00569-X	12L00570-X
4pins/4针	A code/A型	12L00614-X	12L00615-X	12L00616-X
5pins/5针	A code/A型	12L00684-X	12L00685-X	12L00686-X
8pins/8针	A code/A型	12L00732-X	12L00733-X	12L00734-X
12pins/12针	A code/A型	12L00787-X	12L00788-X	12L00789-X
17pins/17针	A code/A型	12L00864-X	12L00865-X	12L00865-X

Pin assignment front view/针位分布前视图

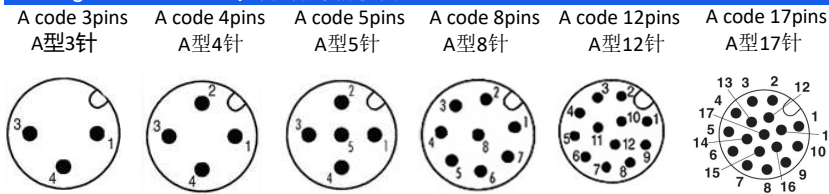

General data/常规数据

Pin Numbers/针数	3pins/3针	4pins/4针	5pins/5针	8pins/8针	12pins/12针	17pins/17针
Rated voltage/额定电压	250V		60V	30V		
Rated current(40°C)/额定电流	4A		2A		1.5A	1.5A
Standards/标准	IEC 61076-2-101					
Termination/焊接方式	Solder and over-mold/焊接和成型					
Degree of protection/防护等级	IP67, IP68, IP69K					
Wire gauge(mm²)/线规(平方数)	0.14mm²-0.75mm²					
Wire gauge(AWG)/线号(平方数)	26AWG-18AWG					
Mechanical operation/插拔次数	>100 mating cycles/大于100次					
Contact resistance/接触电阻	≤5mΩ					
Insulation resistance/绝缘电阻	≥100MΩ					
Connector body/胶芯	TPU					
Male pin/公端子	Brass with gold plated/黄铜镀金					
Female pin/母端子	Phosphorus copper with gold plated/磷铜镀金					
Screw/螺丝	Brass with nickel plated/黄铜镀镍					
Over-mold/成型	TPU					
Shielded shell/屏蔽罩	Brass with nickel plated/黄铜镀镍					
Customs tariff number/海关编码	8518900001					
Environmental compliance/环境符合标准	RoHs, Reach					

M12 A code male to male straight molded cable, shielded/M12, A型公头直头对公头直头连接线, 带屏蔽

Scale drawing/尺寸图

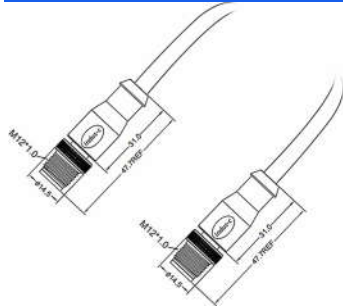

Product photo/产品图



Part number/产品料号

Pins/针数	Code/型	Part number("X" is length millimetre mm)/产品料号("X"表示长度, 单位毫米mm)		
		PVC jacket/PVC外被	PUR jacket/PUR外被	
		-10°C~+80°C	-40°C~+105°C	-40°C~+105°C
3pins/3针	A code/A型	12L00571-X	12L00572-X	12L00573-X
4pins/4针	A code/A型	12L00617-X	12L00618-X	12L00619-X
5pins/5针	A code/A型	12L00687-X	12L00688-X	12L00689-X
8pins/8针	A code/A型	12L00735-X	12L00736-X	12L00737-X
12pins/12针	A code/A型	12L00790-X	12L00791-X	12L00443-X
17pins/17针	A code/A型	12L00867-X	12L00868-X	12L00869-X

Pin assignment front view/针位分布前视图

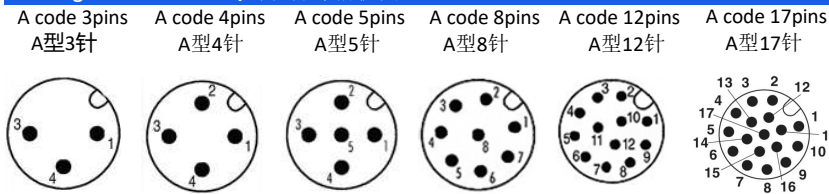

General data/常规数据

Pin Numbers/针数	3pins/3针	4pins/4针	5pins/5针	8pins/8针	12pins/12针	17pins/17针
Rated voltage/额定电压	250V		60V	30V		
Rated current(40°C)/额定电流	4A		2A		1.5A	1.5A
Standards/标准	IEC 61076-2-101					
Termination/焊接方式	Solder and over-mold/焊接和成型					
Degree of protection/防护等级	IP67, IP68, IP69K					
Wire gauge(mm²)/线规(平方数)	0.14mm²-0.75mm²					
Wire gauge(AWG)/线号(平方数)	26AWG-18AWG					
Mechanical operation/插拔次数	>100 mating cycles/大于100次					
Contact resistance/接触电阻	≤5mΩ					
Insulation resistance/绝缘电阻	≥100MΩ					
Connector body/胶芯	TPU					
Pin/端子	Brass with gold plated/黄铜镀金					
Screw/螺丝	Brass with nickel plated/黄铜镀镍					
Over-mold/成型	TPU					
Shielded shell/屏蔽罩	Brass with nickel plated/黄铜镀镍					
Customs tariff number/海关编码	8518900001					
Environmental compliance/环境符合标准	RoHs, Reach					

M12 A code male straight to female right angle molded cable, shielded/M12, A型公头直头对母头弯头连接线, 带屏蔽

Scale drawing/尺寸图

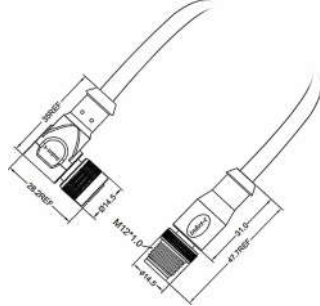

Product photo/产品图



Part number/产品料号

Pins/针数	Code/型	Part number("X" is length millimetre mm)/产品料号("X"表示长度, 单位毫米mm)		
		PVC jacket/PVC外被	PUR jacket/PUR外被	
		-10°C~+80°C	-40°C~+105°C	-40°C~+105°C
3pins/3针	A code/A型	12L00574-X	12L00575-X	12L00576-X
4pins/4针	A code/A型	12L00620-X	12L00621-X	12L00524-X
5pins/5针	A code/A型	12L00690-X	12L00691-X	12L00136-X
8pins/8针	A code/A型	12L00738-X	12L00739-X	12L00740-X
12pins/12针	A code/A型	12L00792-X	12L00793-X	12L00794-X
17pins/17针	A code/A型	12L00870-X	12L00871-X	12L00872-X

Pin assignment front view/针位分布前视图

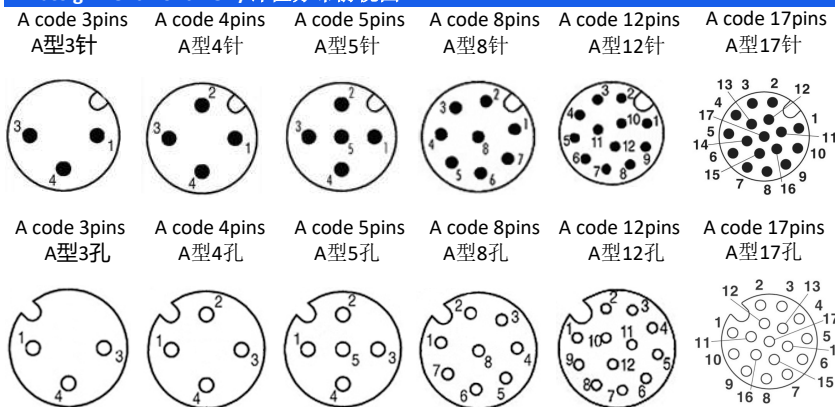

General data/常规数据

Pin Numbers/针数	3pins/3针	4pins/4针	5pins/5针	8pins/8针	12pins/12针	17pins/17针
Rated voltage/额定电压	250V		60V			30V
Rated current(40°C)/额定电流	4A			2A	1.5A	1.5A
Standards/标准	IEC 61076-2-101					
Termination/焊接方式	Solder and over-mold/焊接和成型					
Degree of protection/防护等级	IP67, IP68, IP69K					
Wire gauge(mm²)/线规(平方数)	0.14mm²-0.75mm²					
Wire gauge(AWG)/线号(平方数)	26AWG-18AWG					
Mechanical operation/插拔次数	>100 mating cycles/大于100次					
Contact resistance/接触电阻	≤5mΩ					
Insulation resistance/绝缘电阻	≥100MΩ					
Connector body/胶芯	TPU					
Male pin/公端子	Brass with gold plated/黄铜镀金					
Female pin/母端子	Phosphorus copper with gold plated/磷铜镀金					
Screw/螺丝	Brass with nickel plated/黄铜镀镍					
Over-mold/成型	TPU					
Shielded shell/屏蔽罩	Brass with nickel plated/黄铜镀镍					
Customs tariff number/海关编码	8518900001					
Environmental compliance/环境符合标准	RoHs, Reach					

M12 A code male to female straight molded cable, shielded/M12, A型公头直头对母头直头连接线, 带屏蔽

Scale drawing/尺寸图

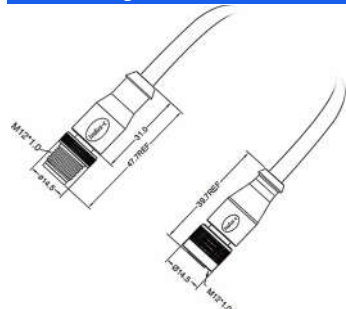

Product photo/产品图



Part number/产品料号

Pins/针数	Code/型	Part number("X" is length millimetre mm)/产品料号("X"表示长度, 单位毫米mm)		
		PVC jacket/PVC外被	PUR jacket/PUR外被	
		-10°C~+80°C	-40°C~+105°C	-40°C~+105°C
3pins/3针	A code/A型	12L00562-X	12L00563-X	12L00564-X
4pins/4针	A code/A型	12L00622-X	12L00119-X	12L00148-X
5pins/5针	A code/A型	12L00692-X	12L00398-X	12L00152-X
8pins/8针	A code/A型	12L00741-X	12L00399-X	12L00390-X
12pins/12针	A code/A型	12L00795-X	12L00796-X	12L00797-X
17pins/17针	A code/A型	12L00873-X	12L00874-X	12L00875-X

Pin assignment front view/针位分布前视图

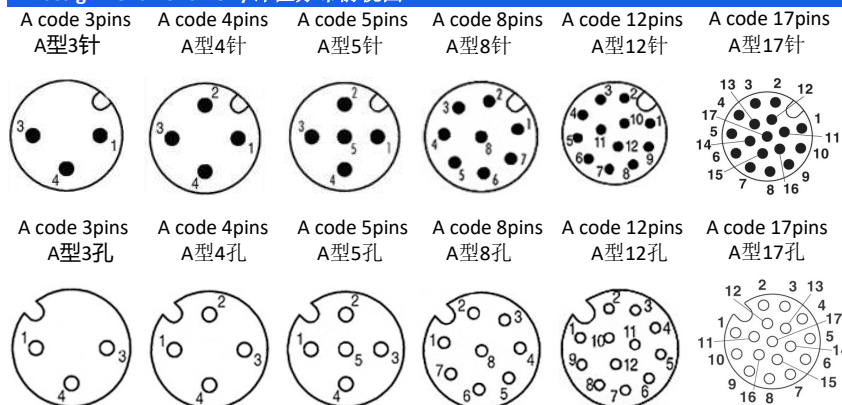

General data/常规数据

Pin Numbers/针数	3pins/3针	4pins/4针	5pins/5针	8pins/8针	12pins/12针	17pins/17针
Rated voltage/额定电压	250V		60V			30V
Rated current(40°C)/额定电流	4A			2A	1.5A	1.5A
Standards/标准	IEC 61076-2-101					
Termination/焊接方式	Solder and over-mold/焊接和成型					
Degree of protection/防护等级	IP67, IP68, IP69K					
Wire gauge(mm²)/线规(平方数)	0.14mm²-0.75mm²					
Wire gauge(AWG)/线号(平方数)	26AWG-18AWG					
Mechanical operation/插拔次数	>100 mating cycles/大于100次					
Contact resistance/接触电阻	≤5mΩ					
Insulation resistance/绝缘电阻	≥100MΩ					
Connector body/胶芯	TPU					
Male pin/公端子	Brass with gold plated/黄铜镀金					
Female pin/母端子	Phosphorus copper with gold plated/磷铜镀金					
Screw/螺丝	Brass with nickel plated/黄铜镀镍					
Over-mold/成型	TPU					
Shielded shell/屏蔽罩	Brass with nickel plated/黄铜镀镍					
Customs tariff number/海关编码	8518900001					
Environmental compliance/环境符合标准	RoHS, Reach					

M12 A code female to female right angle molded cable, shielded/M12, A型母头弯头对母头弯头连接线, 带屏蔽

Scale drawing/尺寸图

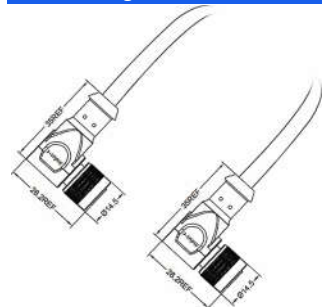

Product photo/产品图



Part number/产品料号

Pins/针数	Code/型	Part number("X" is length millimetre mm)/产品料号("X"表示长度, 单位毫米mm)		
		PVC jacket/PVC外被		PUR jacket/PUR外被
		-10°C~+80°C	-40°C~+105°C	-40°C~+105°C
3pins/3针	A code/A型	12L00577-X	12L00578-X	12L00579-X
4pins/4针	A code/A型	12L00623-X	12L00624-X	12L00625-X
5pins/5针	A code/A型	12L00693-X	12L00694-X	12L00695-X
8pins/8针	A code/A型	12L00744-X	12L00745-X	12L00746-X
12pins/12针	A code/A型	12L00798-X	12L00799-X	12L00800-X
17pins/17针	A code/A型	12L00876-X	12L00877-X	12L00878-X

Pin assignment front view/针位分布前视图

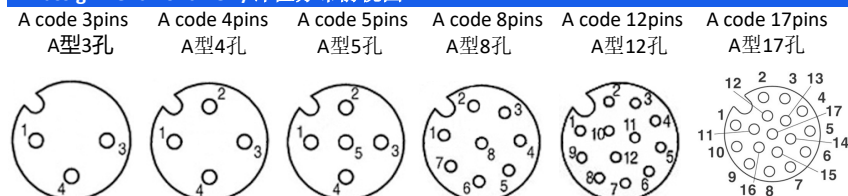

General data/常规数据

Pin Numbers/针数	3pins/3针	4pins/4针	5pins/5针	8pins/8针	12pins/12针	17pins/17针
Rated voltage/额定电压	250V		60V	30V		
Rated current(40°C)/额定电流	4A		2A			
Standards/标准	IEC 61076-2-101					
Termination/焊接方式	Solder and over-mold/焊接和成型					
Degree of protection/防护等级	IP67, IP68, IP69K					
Wire gauge(mm²)/线规(平方数)	0.14mm²-0.75mm²					
Wire gauge(AWG)/线号(平方数)	26AWG-18AWG					
Mechanical operation/插拔次数	>100 mating cycles/大于100次					
Contact resistance/接触电阻	≤5mΩ					
Insulation resistance/绝缘电阻	≥100MΩ					
Connector body/胶芯	TPU					
Pin/母端子	Phosphorus copper with gold plated/磷铜镀金					
Screw/螺丝	Brass with nickel plated/黄铜镀镍					
Over-mold/成型	TPU					
Shielded shell/屏蔽罩	Brass with nickel plated/黄铜镀镍					
Customs tariff number/海关编码	8518900001					
Environmental compliance/环境符合标准	RoHs, Reach					

M12 A code female straight to female right angle molded cable, shielded/M12, A型母头直头对母头弯头连接线, 带屏蔽

Scale drawing/尺寸图

Product photo/产品图

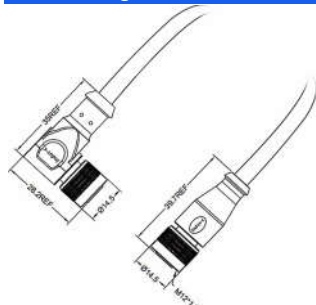

Part number/产品料号

Pins/针数	Code/型	Part number("X" is length millimetre mm)/产品料号("X"表示长度, 单位毫米mm)		
		PVC jacket/PVC外被	PUR jacket/PUR外被	
		-10°C~+80°C	-40°C~+105°C	-40°C~+105°C
3pins/3针	A code/A型	12L00580-X	12L00581-X	12L00582-X
4pins/4针	A code/A型	12L00626-X	12L00627-X	12L00628-X
5pins/5针	A code/A型	12L00696-X	12L00697-X	12L00698-X
8pins/8针	A code/A型	12L00747-X	12L00748-X	12L00749-X
12pins/12针	A code/A型	12L00801-X	12L00802-X	12L00803-X
17pins/17针	A code/A型	12L00879-X	12L00880-X	12L00881-X

Pin assignment front view/针位分布前视图

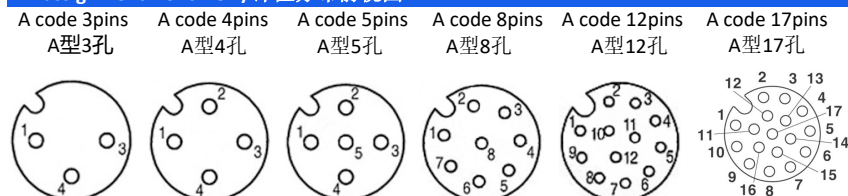

General data/常规数据

Pin Numbers/针数	3pins/3针	4pins/4针	5pins/5针	8pins/8针	12pins/12针	17pins/17针
Rated voltage/额定电压	250V		60V	30V		
Rated current(40°C)/额定电流	4A		2A			
Standards/标准	IEC 61076-2-101					
Termination/焊接方式	Solder and over-mold/焊接和成型					
Degree of protection/防护等级	IP67, IP68, IP69K					
Wire gauge(mm²)/线规(平方数)	0.14mm²-0.75mm²					
Wire gauge(AWG)/线号(平方数)	26AWG-18AWG					
Mechanical operation/插拔次数	>100 mating cycles/大于100次					
Contact resistance/接触电阻	≤5mΩ					
Insulation resistance/绝缘电阻	≥100MΩ					
Connector body/胶芯	TPU					
Pin/母端子	Phosphorus copper with gold plated/磷铜镀金					
Screw/螺丝	Brass with nickel plated/黄铜镀镍					
Over-mold/成型	TPU					
Shielded shell/屏蔽罩	Brass with nickel plated/黄铜镀镍					
Customs tariff number/海关编码	8518900001					
Environmental compliance/环境符合标准	RoHs, Reach					

M12 A code female to female straight molded cable, shielded/M12, A型母头直头对母头直头连接线, 带屏蔽

Scale drawing/尺寸图

Product photo/产品图

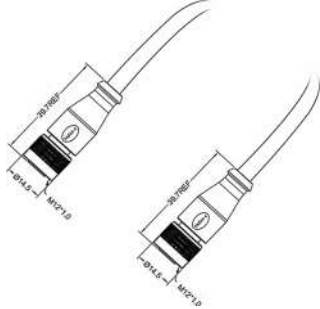

Part number/产品料号

Pins/针数	Code/型	Part number("X" is length millimetre mm)/产品料号("X"表示长度, 单位毫米mm)		
		PVC jacket/PVC外被		PUR jacket/PUR外被
		-10°C~+80°C	-40°C~+105°C	-40°C~+105°C
3pins/3针	A code/A型	12L00583-X	12L00584-X	12L00585-X
4pins/4针	A code/A型	12L00629-X	12L00630-X	12L00631-X
5pins/5针	A code/A型	12L00699-X	12L00700-X	12L00112-X
8pins/8针	A code/A型	12L00750-X	12L00751-X	12L00752-X
12pins/12针	A code/A型	12L00804-X	12L00805-X	12L00806-X
17pins/17针	A code/A型	12L00882-X	12L00883-X	12L00884-X

Pin assignment front view/针位分布前视图

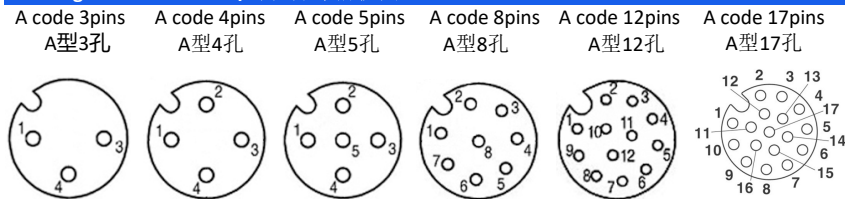

General data/常规数据

Pin Numbers/针数	3pins/3针	4pins/4针	5pins/5针	8pins/8针	12pins/12针	17pins/17针
Rated voltage/额定电压	250V		60V	30V		
Rated current(40°C)/额定电流	4A		2A			
Standards/标准	IEC 61076-2-101					
Termination/焊接方式	Solder and over-mold/焊接和成型					
Degree of protection/防护等级	IP67, IP68, IP69K					
Wire gauge(mm²)/线规(平方数)	0.14mm²-0.75mm²					
Wire gauge(AWG)/线号(平方数)	26AWG-18AWG					
Mechanical operation/插拔次数	>100 mating cycles/大于100次					
Contact resistance/接触电阻	≤5mΩ					
Insulation resistance/绝缘电阻	≥100MΩ					
Connector body/胶芯	TPU					
Pin/母端子	Phosphorus copper with gold plated/磷铜镀金					
Screw/螺丝	Brass with nickel plated/黄铜镀镍					
Over-mold/成型	TPU					
Shielded shell/屏蔽罩	Brass with nickel plated/黄铜镀镍					
Customs tariff number/海关编码	8518900001					
Environmental compliance/环境符合标准	RoHs, Reach					